

700E Deluge Valve Data

Description

BERMAD 700E Deluge Valves are Y Type globe valves with integral unitized double chamber actuator that consists of one single moving assembly, which includes a diaphragm assembly, a flat seal disk and a stainless steel removable seat. These automatic water control valves are designed for high pressure service, in vertical or horizontal installations and are available in diameter sizes from 1½" to 16"; DN40 to DN400.

The BERMAD 700E valves are used for water flow control in Deluge, Pressure Control Deluge, Preaction or Water/Foam systems, and are manufactured from materials suitable for freshwater or alternative for seawater, foam concentrate or other corrosive fluids.

The 700E Deluge Valve is held closed by system water pressure trapped in the control chamber. When the releasing system operates, pressure is released from the control chamber, and the seal disc opens to allow water to flow into the system.

The 700E valve body design includes a single, full bore seat with unobstructed flow path, free of any in-line ribs, supporting cage, or stem guides.

The 700E "Y Type" design provides high flow capabilities with minimum head loss.

The integral unitized double-chambered actuator provides a combination of positive, immediate response with smooth hammer-free, drip-tight closing.

The whole actuator can be easily removed for a quick in-line inspection and servicing.

Valve actuation is accomplished by one moving assembly which includes a replaceable flat diaphragm, harnessed to the diaphragm assembly, a stainless steel stem and a flat seal disk assembly.

The balanced seal-disk assembly with its resilient seal enables controlled actuation, high durability and perfect drip-tight sealing, even under harsh conditions.

Accessories

The BERMAD 700E Deluge Valve shall be trimmed with the original components and accessories per specification and in accordance with valve functions and applications.

Where additional specifications and/or signaling devices are required for a specific application, refer to system data for the system used, and to the BERMAD data sheet and Installation, Operation & Maintenance for specific model required.



Main Features

- High Pressure Construction – 400 psi (28 bar) rating available
- Integral unitized double chamber actuator with single moving assembly
- In-line serviceable, field replaceable internals
- Obstacle free, full bore
- Available in corrosion resistant materials
- Designed to be reset without opening the valve
- Compatible with electric/hydraulic/pneumatic release and pressure control trim systems

Approvals

- UL Listed to UL 260 from 5 to 300 psi; 0.3 to 21 bar WP, 2" through 10"; DN50 through DN250
- ABS Approved for 300 psi; 21 bar WP, 1½" through 12"; DN40 through DN300
- Lloyd's Register Type Approval for 300 psi; 21 bar WP, 1½" through 16"; DN40 through DN400
- Fire Test Certified to ISO 6182 part 5, 1½" through 16"; DN40 through DN400

Notes:

1. The 700E valve shall be trimmed with specific components & accessories.
2. The 700E valve must be installed and maintained in compliance with the most recent BERMAD publications.

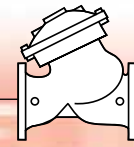

Construction Materials

The BERMAD 700E valves are available in a variety of materials to ensure optimal suitability for a wide range of applications. For operation involving exposure to internal and/or external corrosive conditions, valves are constructed from corrosion-resistant materials making them suitable for use with seawater, brackish water, or corrosive environments such as seashore, petrochemical and other industrial facilities.

Standard Configurations

Item Number	Description	Firewater Valve
1	Cover	Ductile Iron
2	Cover Bolt	Stainless Steel
3	Cover Nut	Stainless Steel
4	Separation Partition	Ductile Iron
5	Stud	Z.C. Plated Steel
6	Stud Nut	Z.C. Plated Steel
7	Valve Body	Ductile Iron
8	Spring	S.S. 302
9	Removable Seat	S.S. 304
10	Seal	NBR (Buna-N)
11	Upper Plug (6-20")	Brass
12	Shaft Lock Nut	S.S. 303
13	Shaft Nut	S.S. 303
14	Diaphragm Washers	S.S. 431
15	Diaphragm	NBR (Buna-N)
16	Bearing Screw	S.S. 303
17	Bearing	Bronze
18	Shaft	S.S. 303
19	Seal Disk	S.S. 431

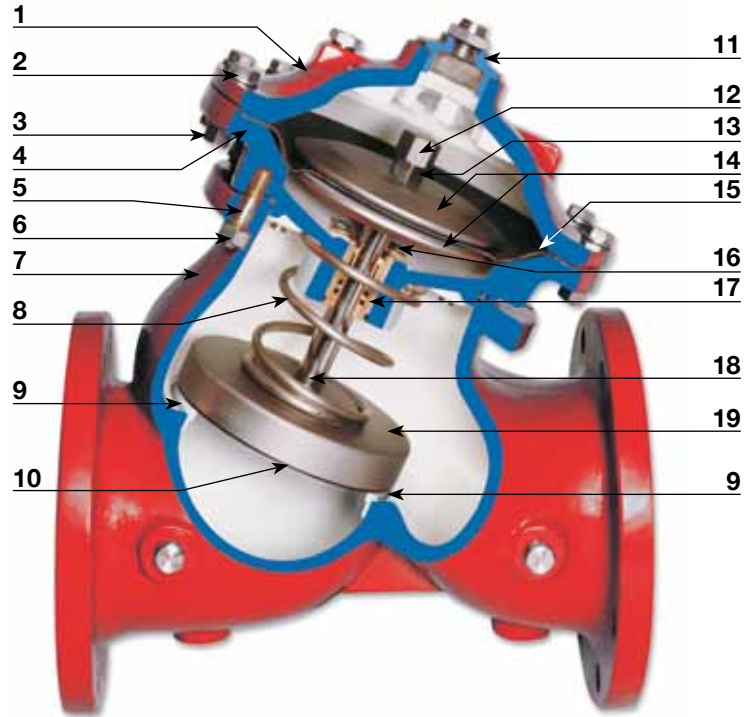

Specifications

Castings

- Ductile Iron to ASTM A536 65-45-12 (coated)
- Cast Steel ASTM A216 Grade WCB (coated)
- Nickel Aluminum Bronze ASTM B148 C95800
- Stainless Steel 316 ASTM A351 Grade CF8M
- Super Duplex ASTM A890 Grade 5A
- Hastelloy C-276

Bolting:

- External Bolting: S.S.316 to ASTM A320 Gr.B8F

Internal Wetted Parts:

- Stainless Steel 303 ASTM A582 95B S30300A
- Stainless Steel 304 ASTM A743 Grade CF8
- Stainless Steel 431 ASTM A743 Grade CA15M
- Bronze ASTM B505 Grade C83600
- Internal Spring - S.S. 302

Optional Internal Wetted Parts:

- Stainless Steel 316 ASTM A351 Grade CF8M
- Nickel Aluminum Bronze ASTM B148 C95800
- Monel 400
- Super Duplex ASTM A890 Grade 5A
- Hastelloy C-276
- Internal Spring - Inconel

Elastomers (Diaphragm & Seals)

- NBR, Polyamide fabric reinforced Nitrile (Buna-N), Temperature Rating 80°C
- EPDM, Polyamide fabric reinforced Ethylene-Propylene, Temperature Rating 90°C

Coating

- Electrostatic Powder Coating Polyester
- High Built Epoxy Fusion-Bonded with UV Protection, Anti-Corrosion
- Color: Fire Red to RAL 3002

Note: Internal & External coating applied on Ductile Iron or Cast Steel Castings only.

Pressure Rating

Material	End Connection Standard Inlet & Outlet	Class & Type	Max. working pressure	
			psi	bar
Ductile Iron	Flanged ANSI B16.42	#150RF	250	17.4
	Flanged ANSI B16.42	#300RF	400	28
	Flanged ISO 7005-2	PN 16	235	16
	Flanged ISO 7005-2	PN 25	365	25
	Grooved ANSI C606	300	400	25
	Threaded BSP/NPT	300/PN25	400	25
C.Steel, SS316, Duplex & Hastelloy	Flanged ANSI B16.5	#150RF	250	17.4
	Flanged ANSI B16.5	#300RF	400	28
	Flanged ISO 7005-2	PN16	235	16
	Flanged ISO 7005-2	PN25	365	25
	Threaded BSP/NPT	300/PN25	400	25
Ni-Al Bronze	Flanged ANSI B16.24	#150RF	250	17.4
	Flanged ANSI B16.24	#300RF	400	28
	Flanged ISO 7005-2	PN 16	235	16
	Flanged ISO 7005-2	PN25	365	25

Notes

1. Factory pressure testing: Each valve is tested at 1.6 of pressure rating.
2. Water Temperature: 0.5 - 80°C (33 - 122°F)
3. Standard flange facing: Raised Face (RF), Serrated Finish. Flat Face (FF) flanges available on request.

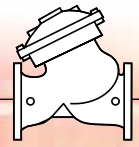

Flow Chart

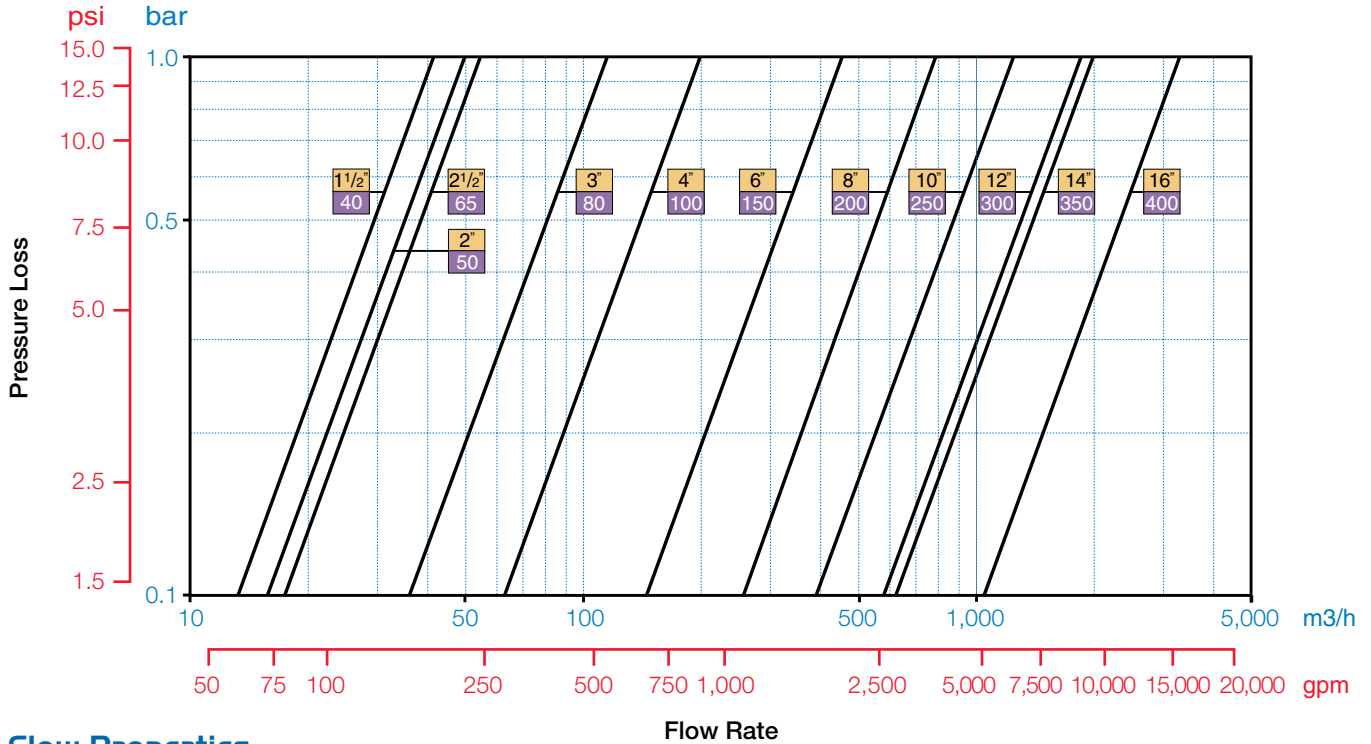

Flow Properties

DN	40-50	65	80	100	150	200	250	300	350	400	
Inch	1 1/2"-2"	2 1/2"	3"	4"	6"	8"	10"	12"	14"	16"	
"Y"-Type	Kv-Y	50	55	115	200	460	815	1,250	1,850	1,990	3,310
	Cv-Y	58	64	133	230	530	940	1,440	2,140	2,300	3,820
	K-Y	3.9	9.2	4.9	3.9	3.7	3.8	3.9	3.7	5.9	3.7
	Leq-m, Y	10.3	33.4	21.6	23	37.5	53.9	70	85.6	159.9	112.7
	Leq-feet, Y	33.8	109.5	70.8	75.6	123	176.9	229.5	280.8	524.5	369.6
Angle	Kv-A	55	61	127	220	506	897	1,375	2,035	2,189	3,641
	Cv-A	64	70	146	250	580	1,040	1,590	2,350	2,530	4,210
	K-A	3.2	7.6	4.0	3.2	3.1	3.1	3.2	3.1	4.9	3.0
	Leq-m, A	8.5	27.6	17.8	19.0	37.0	44.6	57.8	70.7	132.1	93.1
	Leq-feet, A	28	90.5	58.5	62.5	101.6	146.2	189.7	232	433.4	305.5

Valve flow coefficient, Kv or Cv $Kv(Cv)=Q \sqrt{\frac{Gf}{\Delta P}}$

Where:

- Kv = Valve flow coefficient (flow in m³/h at 1bar Diff. Press.)
- Cv = Valve flow coefficient (flow in gpm at 1psi Diff. Press.)
- Q = Flow rate (m³/h ; gpm)
- ΔP = Differential pressure (bar ; psi)
- Gf = Liquid specific gravity (Water = 1.0)

Cv = 1.155 Kv

Flow resistance or Head loss coefficient, $K=\Delta H \frac{2g}{V^2}$

Where:

- K = Flow resistance or Head loss coefficient (dimensionless)
- ΔH = Head loss (m ; feet)
- V = Nominal size flow velocity (m/sec ; feet/sec.)
- g = Acceleration of gravity (9.81 m/sec² ; 32.18 feet/sec²)

Equivalent Pipe Length, Leq $Leq=Lk \cdot D$

Where:

- Leq = Equivalent nominal pipe length (m ; feet)
- Lk = Equivalent length coefficient for turbulent flow in clean commercial steel pipe (SCH 40)
- D = Nominal pipe diameter (m ; feet)

Note:

The Leq values given are for general consideration only. Actual Leq may vary somewhat with each of the valve sizes.



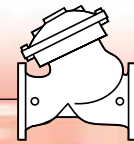

Flanged

Size DN mm (inch)		40 (1½")	50 (2")	65 (2½")	80 (3")	100 (4")	150 (6")	200 (8")	250 (10")	300 (12")	350 (14")	400 (16")
ANSI #150, ISO PN 16	L (mm)	10	205	222	250	320	415	500	605	725	733	990
	LG ⁽⁴⁾ (mm)	-	-	-	250	320	415	500	-	-	-	-
	W (mm)	165	165	178	200	223	320	390	480	550	550	740
	R (mm)	78	83	95	100	115	143	172	204	242	268	300
	La (mm)	124	124	149	152	190	225	265	320	396	400	450
	ha (mm)	85	85	109	102	127	152	203	219	273	279	369
	Hy (mm)	239	244	257	305	366	492	584	724	840	866	1,108
	Ha (mm)	227	227	241	281	342	441	545	633	777	781	1,082
	Weight Y (kg)	10.6	10.6	13	22	37	75	125	217	370	381	846
	Weight A (kg)	10	10	12	21.5	35	71	118	205	350	370	800
ANSI #300, ISO PN 25	L (mm)	210	210	222	264	335	433	524	637	762	767	1,024
	W (mm)	165	165	185	207	250	320	390	480	550	570	740
	R (mm)	78	83	95	105	127	159	191	223	261	295	325
	La (mm)	124	124	149	159	200	234	277	336	415	419	467
	ha (mm)	85	85	109	109	127	165	216	236	294	299	386
	Hy (mm)	239	244	257	314	378	508	602	742	859	893	1,133
	Ha (mm)	227	227	251	287	342	454	558	649	796	801	1,099
	Weight Y (kg)	12.2	12.2	15	25	43	85	146	245	410	434	900
	Weight A (kg)	11.5	11.5	13.5	23	41	81	138	233	390	421	855
	Ports	a ⁽¹⁾ (mm)	½	½	½	½	½	½	½	½	½	½
b ⁽¹⁾ (mm)		½	½	½	½	½	½	½	½	½	½	½
c ⁽¹⁾ (mm)		¾	¾	¾	¾	¾	2	2	2	2	2	2
d ⁽²⁾ (optional) (mm)		¾	¾	1½	1½	2	2	2	2	2	2	2
Control Vol. ⁽³⁾ (Liter)		0.125	0.125	0.125	0.3	0.45	2.15	4.5	8.5	12.4	12.4	29.9

(1) (a), (b), (c) are NPT thread ports

(2) (d) is BSPT threaded Optional drain port

(3) (Control Volume) is Control Chamber Displacement Volume of liquid pushed when valve opens

(4) LG for Grooved ends (see available sizes)

Y Body Type

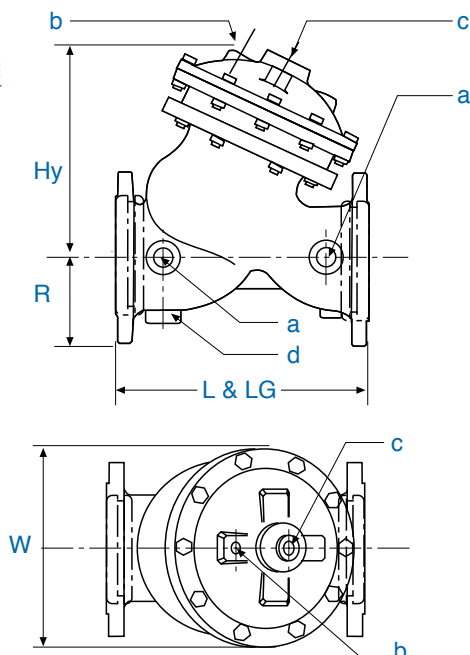

Angle Body Type

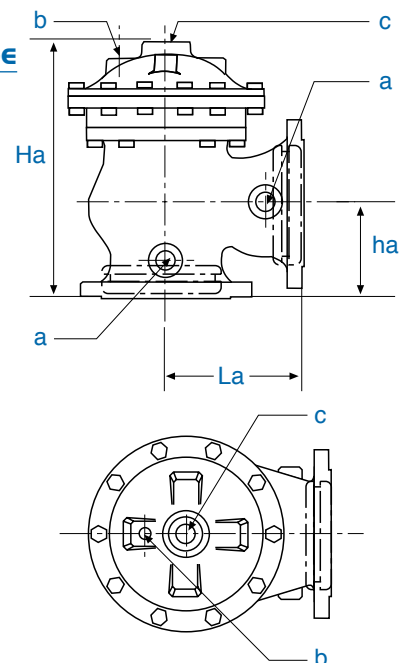

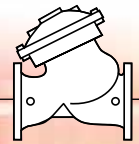

US English

Flanged

Size (inch)		1½"	2"	2½"	3"	4"	6"	8"	10"	12"	14"	16"
ANSI #150, ISO PN 16	L (inch)	8.1	8.1	8.3	9.8	12.6	16.3	19.7	23.8	28.5	28.9	39.0
	LG ⁽⁴⁾ (inch)	-	-	-	9.8	12.6	16.3	19.7	-	-	-	-
	W (inch)	6.1	6.1	7.0	7.9	8.8	12.6	15.4	18.9	21.7	21.7	29.1
	R (inch)	3.1	3.3	3.7	3.9	4.5	5.6	6.8	8.0	9.5	10.6	11.8
	La (inch)	4.9	4.9	5.9	6.0	7.5	8.9	10.4	12.6	15.6	15.7	17.7
	ha (inch)	3.3	3.3	4.3	4	5	6	8	8.6	10.7	11	14.5
	Hy (inch)	9.4	9.6	10.1	12	14.4	19.4	23	28.5	33.1	34.1	43.6
	Ha (inch)	8.9	8.9	9.9	11.1	13.5	17.4	21.5	24.9	30.6	30.7	42.6
	Weight Y (Lbs.)	23	23	29	49	82	165	276	478	816	840	1,865
	Weight A (Lbs.)	22	22	27	47	77	157	260	452	772	216	1,764
ANSI #300, ISO PN 25	L (inch)	8.3	8.3	8.7	10.4	13.2	17	20.6	25.1	30	30.2	40.3
	W (inch)	6.5	6.5	7.3	8.1	9.8	12.6	15.4	18.9	21.7	22.4	29.1
	R (inch)	3.1	3.3	3.7	4.1	5	6.3	7.5	8.8	10.3	11.6	12.8
	La (inch)	4.9	4.9	5.9	6.3	7.9	9.2	10.9	13.2	16.3	16.5	18.4
	ha (inch)	3.3	3.3	4.3	4.3	5.3	6.5	8.5	9.3	11.6	11.8	15.2
	Hy (inch)	9.4	9.6	10.1	12.4	14.9	20	23.7	29.2	33.8	35.2	44.6
	Ha (inch)	8.9	8.9	9.9	11.3	13.8	17.9	22	25.6	31.3	31.5	43.3
	Weight Y (Lbs.)	27	27	33	55	95	187	322	540	904	957	1,984
	Weight A (Lbs.)	25	25	30	51	90	179	304	514	860	928	1,88
	Ports	a ⁽¹⁾ (inch)	½	½	½	½	½	½	½	½	½	½
b ⁽¹⁾ (inch)		½	½	½	½	½	½	½	½	½	½	½
c ⁽¹⁾ (inch)		¾	¾	¾	¾	¾	2	2	2	2	2	2
d ⁽²⁾ (optional) (inch)		¾	¾	1½	1½	2	2	2	2	2	2	2
Control Vol. ⁽³⁾ (Gal.)		0.04	0.04	0.04	0.08	0.12	0.57	1.19	2.25	3.28	3.28	7.88

- (1) (a), (b), (c) are NPT thread ports
- (2) (d) is BSPT threaded Optional drain port
- (3) (Control Volume) is Control Chamber Displacement Volume of liquid pushed when valve opens
- (4) LG for Grooved ends (see available sizes)

Y Body Type

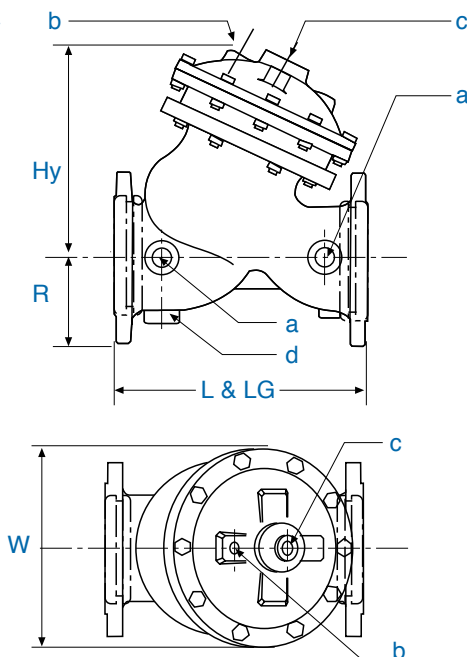

Angle Body Type

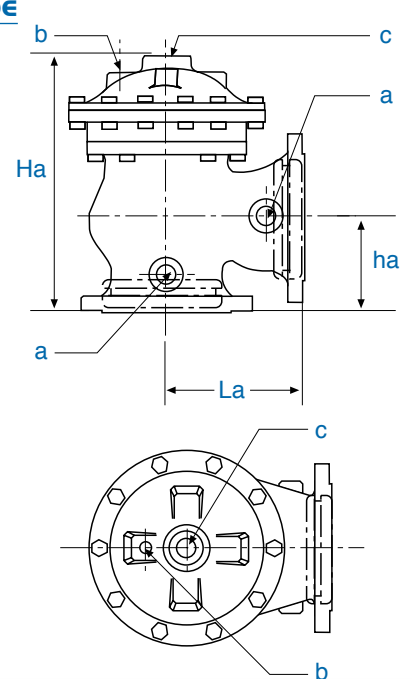

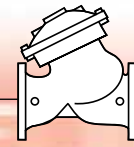

Installation

Proper operation of the 700E Deluge Valves depends upon their trim being installed in accordance with the appropriate trim configuration.

Notes:

- Wet pilot height should not exceed “Maximum Elevation Above Valve” (see data for specific model).
- Any deviation in trim size or arrangement may adversely affect the proper operation of the deluge valve.
- All the pilot system devices, must be UL Listed and compatible with the particular deluge system. Refer to current “UL Listed Fire Protection Equipment Directory”.

Warning: The deluge valve and trim must be installed only in areas where they will not be subject to freezing temperatures.

Installation Instructions

1. Allow enough room around the valve assembly for any adjustments and future maintenance.
2. Before the valve is installed, flush the pipeline to remove any dirt, scale, debris, etc. Not flushing the line may result in the valve's becoming inoperable.
3. Install the valve in the pipeline so that the valve flow arrow appearing on the body casting is pointing in the desired direction. Ensure that the valve is positioned so that the actuator assembly can be easily removed for future maintenance.
4. Ensure that the Control Trim is mounted properly and all other components are positioned correctly as per illustration.
5. After installation in the main line, carefully inspect/correct any damaged accessories, piping, tubing, or fittings. Ensure that there are no leaks.
6. Install the components comprising the Deluge Trim Package in their proper positions in compliance with all instructions, drawings, and technical specifications describing the BERMAD Deluge Valve, according to the relevant illustration.
7. All additional accessories, although not packed together with the BERMAD Deluge Valve, must be installed as shown in the relevant P&ID and other illustrations.

Operation

Principle of Operation

The BERMAD 700E Deluge Valve (assembled with specific trim) is suitable for systems that include adequate detecting and piping systems with open nozzles. The deluge valve prevents water from entering system piping until required. The deluge valve is kept closed by pressure applied to the upper control chamber through a restricted priming line.

In the SET position, the water pressure supplied through the priming line is trapped in the upper control chamber of the deluge valve by a check valve, and by the normally closed release device.

The pressure trapped in the upper control chamber of the deluge valve presses the valve seal disk down, thereby sealing the valve and keeping the system piping dry.

Under conditions of FIRE, when the pressure is released from the upper control chamber by the opening of the automatic releasing device or by manual release, the deluge valve opens and allows the inlet supply water to flow through the valve and into the system piping and alarm devices.

Warning: Whenever the handle of the Manual Emergency Release is pulled, pressure is released from the upper control chamber, the deluge valve will open, and water will flow into system piping and alarm devices.

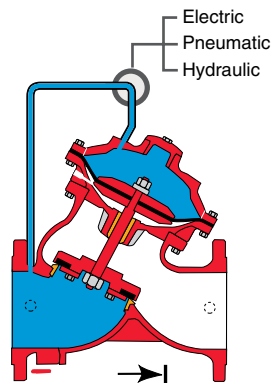

Valve Closed (Set Position)

Line pressure applied to the upper control chamber of the valve creates a superior force that moves the valve to the closed position and provides drip tight sealing.

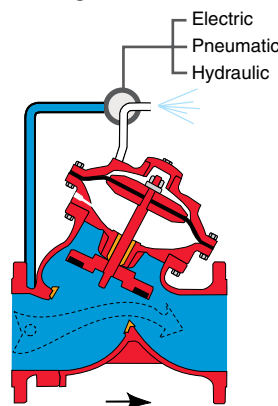

Valve Open (Operating Conditions)

Releasing the pressure from the upper control chamber to atmosphere or some other lower pressure zone causes the line pressure acting on the seal disk to move the valve to the open position.

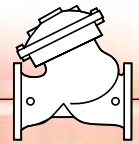

Placing in Service/Resetting

The deluge valve and the control trim shall be Placed in Service with accordance to the most recent IOM procedures for the specific model.

After all relevant instructions are performed, slowly open the supply-isolating valve and check that no water flows into the system.

The system is now operational and in stand-by mode.

Maintenance

Bermad Deluge Valves require no lubrication, no packing tightening, and require a minimum of maintenance.

Removing the System from Service

Warning: When taking a deluge system out of service, a fire patrol should be established in the system area. If automatic fire alarm signaling equipment is utilized, the proper authority should be notified that the system is being removed from service. The insuring body and owner's representative should also be notified when the system is being taken out of service.

Removal Instructions

1. Shut off the main supply-isolating valve.
2. Close the priming line valve to the deluge valve control chamber.
3. Open all drain valves.
4. Release the water pressure from the control chamber of the deluge valve by pulling the manual emergency release.
5. Place "Fire Protection System Out of Service" signs in the area protected by the system.

Inspection and Testing

1. **Warning:** Do not turn off the water supply to make repairs without placing a roving fire patrol in the area covered by the system. The patrol should continue until the system is back in service.
2. Prior to turning off any valves or activating any alarms, notify local security guards and the central alarm station, if used, to avoid signaling a false alarm.
3. The deluge valve and the control trim shall be maintained with accordance to the most recent IOM procedures for the specific model. A periodic test schedule should be established also with accordance to the site conditions and owner regulations.
4. Take all additional measures as required by NFPA-25 "standard for the inspection, testing, and maintenance of water-based fire protection systems".

5. The system should be checked weekly for "Normal Conditions".
6. Clean the priming strainer prior to any resetting of the deluge valve.
7. The deluge valve must be activated at full flow at least annually. Take all necessary precautions to drain water and prevent damage in the area protected by the system.
8. After about five years of operation, replacement of diaphragm and other elastomers is recommended. Remove the actuator and disassemble it. Clean the seat area from sediments, clean the control tubing entry holes, and install a new diaphragm and other elastomers in place.

Spare Parts

1. The Diaphragm and the Seals are the only spare parts needed for the main deluge valve, see attached "Valve Disassembly and Parts Breakdown" illustration.
2. It is not recommended to store spare rubber parts for long periods (rubber in improper storage conditions can harden and crack).
3. Contact your Bermad representative and order new rubber parts when required.

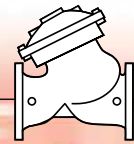

Valve Disassembling Parts Breakdown

