

NOZZLE SCHEDULE			
MARK	QTY	SIZE / RATING	DESCRIPTION
N1	1	6" RFSO CL150	INLET
N2	1	6" RFSO CL150	OUTLET
N3	2	1/2" NPT CL3000	PRESSURE GAUGE
N4	1	1/2" NPT CL3000	VENT
N5	1	2" NPT CL3000	CLEAN DRAIN
N6	1	1/2" NPT CL3000	DIRTY DRAIN

VESSEL DESIGN CONDITIONS	
CODE:	ASME SECTION VIII DIV. 1, 2019 EDITION
M.A.W.P.: 150 PSI @ 400°F	M.D.M.T.: -20°F @ 150 PSI
M.A.W.P.: FV PSI @ 400°F	HYDROTEST PRESS: 210 PSI
CORROSION ALLOWANCE: N/A	SERVICE: UNK. LIQUID, NON-LETHAL
STAMP: U	RADIOGRAPHY: N/A
PWHT: N/A	GASKET: <input type="checkbox"/> BUNA <input type="checkbox"/> VITON <input type="checkbox"/> EPDM
MATERIAL: SS304	<input type="checkbox"/> OTHER: _____
NOTES:	FACTORY INSTALLED OPTIONS:
DRY WEIGHT: 540 LBS	<input type="checkbox"/> STAINLESS STEEL BOLTING (SS316)
SHIPPING WEIGHT: 600 LBS	<input type="checkbox"/> MESH LINED BASKETS: _____ MESH
VOLUME: 10.75 CU. FT.	<input type="checkbox"/> N3 DIFFERENTIAL PRESSURE GAUGE
INTERNALS: 7x SIZE 2 BASKETS (SS304)	TYPE: _____
	<input type="checkbox"/> N4 PRESSURE RELIEF VALVE
	TYPE: _____
	<input type="checkbox"/> N4 AIR ELIMINATOR
	TYPE: _____
	<input type="checkbox"/> N4 VENT VALVE
	<input type="checkbox"/> N5/N6 DRAIN VALVES

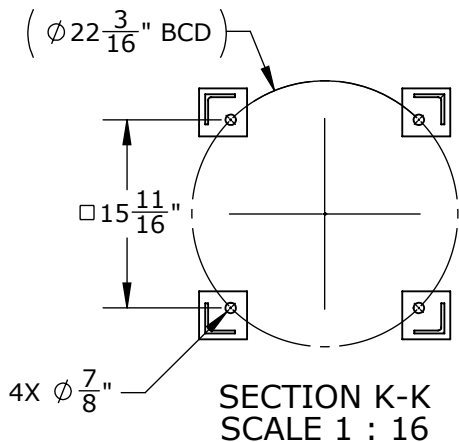
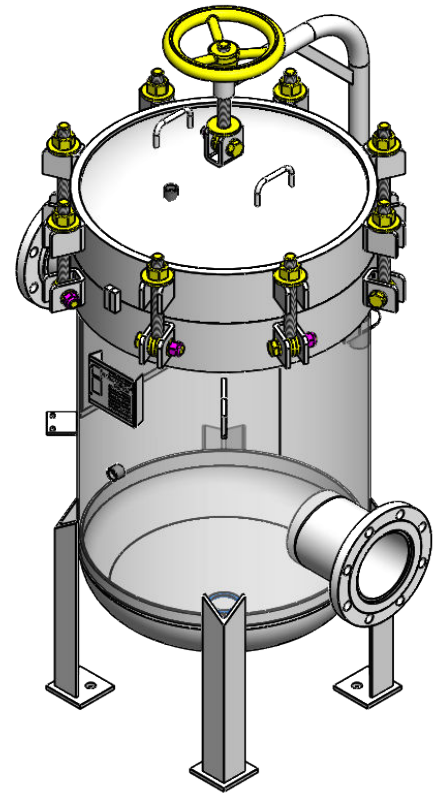
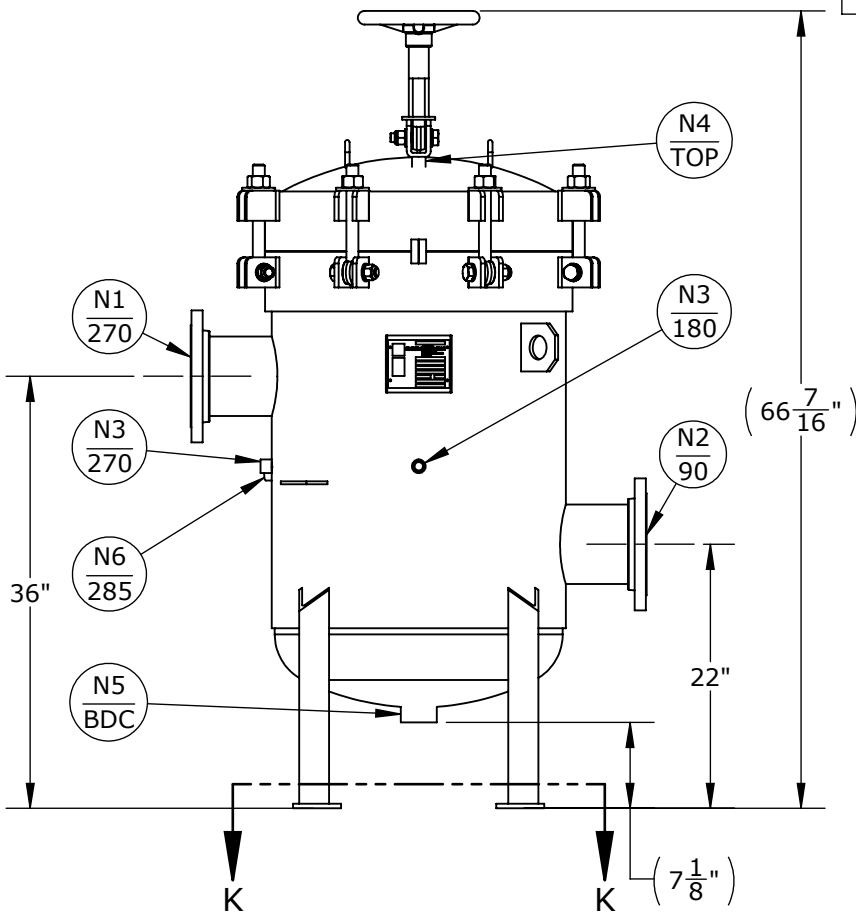

APPROVED WITH MARK-UPS APPROVED

<p>THIRD ANGLE PROJECTION</p> <p>TOLERANCES-UNLESS OTHERWISE NOTED</p> <p>DECIMAL .X = ±.1" .XX = ±.02" .XXX = ±.005"</p> <p>FRACTIONAL = ±1/8"</p> <p>ANGULAR = ± 1°</p> <p>MAX. MACHINED SURFACE FINISH 125/√</p>	<p>FIL-TREK CORPORATION</p> <p>55 Stafford Court Cambridge, Ontario N1T 1B3 Canada</p> <p>Phone: (519) 623-7448 Fax: (519) 623-8807 Email: info@fil-trek.com Website: www.fil-trek.com</p>				
	<p>THIS DRAWING IS THE PROPERTY OF 'FIL-TREK CORPORATION' AND MUST NOT BE COPIED OR USED IN ANY WAY DETRIMENTAL TO THE CORPORATION</p> <p>EQUIPMENT: LP SERIES (BAG FILTER VESSEL)</p> <p>MODEL NO: S4LP24-712-6F-A-150A</p> <p>CUSTOMER:</p>				
VESSEL QUANTITY:	DRAWN: AJ	DATE: 2020-03-05	SERIAL No.	Part No. 002004-01118	REV. No. 0
	CHK'D: TS	SCALE: NTS			