

The logo for ICEcube, featuring the word "ICE" in white and "cube" in black on a blue rectangular background.

TM

Cooling Solutions



## EX Series Air Conditioners

Zone 1 ATEX and IECEx Hazardous Locations

# OPERATION AND INSTALLATION MANUAL

\*\*\* IMPORTANT \*\*\*

PLEASE READ this manual and follow the instructions for safe and satisfactory installation and operation of this system. Keep this manual for future reference. Some information may not apply to all systems.

RELATED DRAWING; DO NOT CHANGE WITHOUT AUTHORIZED PERSON APPROVAL

**Introduction**..... 3

**Basic Unit Operation** ..... 3

**Preservation Instructions** ..... 4

**Pre-Installation Test** ..... 5

**Preparing the Enclosure**..... 6

**Mechanical Installation Instruction** ..... 7

**Electrical Installation Instruction** ..... 8

**Operating Your System**..... 10

**Thermostat Operation** ..... 10

**Service and Maintenance Instruction** ..... 11

**Trouble Shooting**..... 12

**Schematic Wiring Diagrams** ..... 14

**Specification Drawing**..... 15

**IQ4000EX** ..... 15

**IQ5000EX** ..... 16

**IQ6000EX** ..... 17

**IQ8000EX** ..... 18

**IQ10000EX** ..... 19

**IQ12000EX** ..... 20

**IQ4-5-6000EX Gasket and Cutout** ..... 21

**IQ8-10-12000EX Gasket and Cutout** ..... 22

**Notes:**..... 25

## Introduction

Ice Qube computer and electronics enclosure cooling systems have been designed to provide a safe environment for your equipment. Our cooling systems provide this environment by cooling and dehumidifying the enclosure that houses your equipment while providing an efficient, modern, and aesthetically pleasing package requiring minimal maintenance. Our closed-loop circulation design also protects your equipment from air-borne dust and contaminants which may hinder your equipment operations and cause unnecessary downtime. Ice Qube offers various models of cooling systems ranging in cooling capacity from 1,000 to 27,000 BTU per hour to provide air conditioning systems for many of your environmental needs, including hazardous locations. Ice Qube cooling systems are available in top and side mount packages.

## Basic Unit Operation

The Ice Qube Thermal Management System (TMS) is a combination of several systems that function simultaneously to maintain environmentally friendly conditions for your equipment within the enclosure. The three main thermal related systems that we employ are the closed-loop cold air supply stream, the heat rejection air stream, and the vapor-compression refrigeration system.

The closed-loop cold air supply stream circulates cold air from the Ice Qube TMS to your electronics enclosure. This air returns to the Ice Qube TMS bringing with it unwanted heat and humidity from inside your enclosure. Heat and humidity is then removed by a heat exchanger which is part of the vapor-compression refrigeration system.

At the heart of the vapor-compression refrigeration system is a quiet, energy efficient rotary compressor, which circulates environmentally friendly NON-CFC refrigerant to transfer heat from the heat exchanger (evaporator) located within the closed-loop air stream to a heat exchanger (condenser) located in the heat rejection air system. In the heat rejection air stream, air is circulated from the ambient air surrounding the enclosure, through a filter, and across the warm heat exchanger. Here, heat from the enclosure is transferred from the warm heat exchanger to the heat rejection air stream and dissipated to the ambient air.

**Condenser Heat  
Rejection Air Stream**

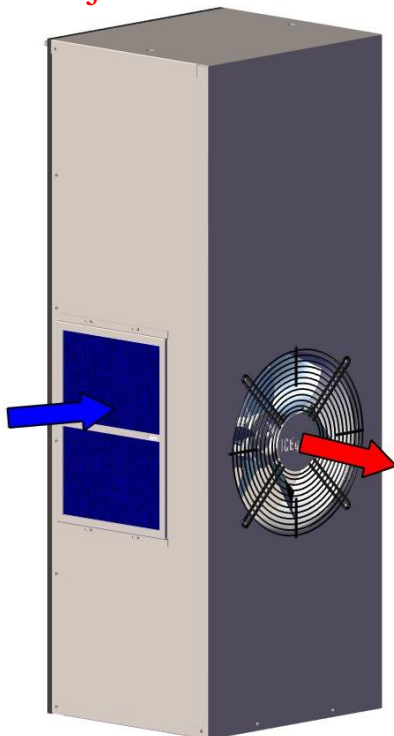

**Evaporator Cold  
Air Supply Stream**

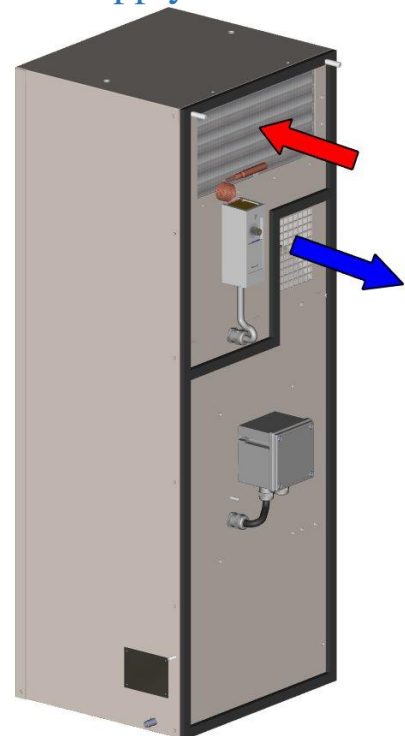

## Preservation Instructions

### Unpacking Inspection

**Caution:** *It is recommended using gloves and protective eyewear when unpacking*

Verify product is as identified on the packing list. Air conditioner should arrive banded to pallet and wrapped with an outer protective clear plastic membrane material in the proper upright position. See arrows on packaging for verification. Any evidence of damage should be noted on the freight bill. The freight carriers claim procedure should be followed. **Ice Qube cannot accept responsibility for damages that occur during shipping.** If the shipping container was damaged or marred in any way, check for scratches, dents, loose hardware, presence of oil or any other irregularities with the Ice Qube TMS.

### Package Contents

Included in the shipment with the air conditioner will be:

1. Operation manual
2. Mounting hardware
3. (2) Bolts w/ washer for replacing lifting lugs after final installation

### Handling

Ice Qube recommends that the unit remains in the proper upright position, as indicated on the shipping container. The unit must remain upright for a minimum of 24 hours before initial operation to ensure oil has returned to the compressor. Operation before the 24-hour time may cause compressor damage and shorten the life of the system. *Operation before this 24-hour period will void all warranties.*

### Storage

It is recommended the air conditioner be stored in the original packaging in a secure area where it will not be damaged. If the packaging is to be removed, use lifting lugs to move the air conditioner. Before use, check that the lifting lugs on top of the air conditioner are secure and have not loosened during shipment. The storage space temperature should be in the range of -40 to 60°C (-40 to 140°F) in a non-condensing environment with a relative humidity of 0 to 95%.

**CONDITIONS OF ACCEPTABILITY:** When installed in the end use equipment, the following considerations are to be examined:

1. Please contact Ice Qube with any questions regarding services before opening or altering the system from its original factory configuration.
2. Surfaces are to be cleaned only with a damp cloth to avoid build-up of electrostatic charge.
3. Cable type should be a flexible conduit that is effectively clamped to prevent twisting and pulling.

## Pre-Installation Test

Before installing the Ice Qube system on your enclosure, Ice Qube recommends that the unit operates for 20-30 minutes to ensure it is functioning properly. Although the Ice Qube TMS has been tested at the factory, internal damage may have occurred during shipping which may have not been apparent during the unpacking inspection.

1. Place the system on a solid base such as a workbench or table. Ensure that the weight of the unit will be supported. Be sure to allow adequate space for airflow. The cold air supply stream and the heat rejection air stream must not be restricted.
2. Check that the warm air system filter(s) is(are) in place.
3. Check the data tag for proper electrical requirements. The data tag lists the design voltage and amperage requirements of the system. Verify that the electrical supply where the system will be connected has the proper capacity. After noting the above, connect power from a properly grounded electrical connection. The use of an extension cord is not recommended. **See Electrical Installation Instruction for wiring details. (Page 8)**

***Note: If any unusual noise or vibration is present during the testing procedure, immediately disconnect the power and inspect the exterior of the unit for the cause of noise or vibration. If necessary, Contact Ice Qube immediately to determine cause of the noise/vibration.***

4. The air conditioner will not operate if the room air temperature is below the set point. Factory set point: 77°F (25°C)
5. ***Note: Adjust the set-point to a temperature lower than the room temperature in order for the air conditioner to operate. Refer to Thermostat Operation to change the factory set points. (Page Error! Bookmark not defined.)***
6. With the compressor and both blowers functioning, allow the unit to operate for 20 to 30 minutes. This will provide sufficient time for the vapor compression system to achieve equilibrium. Measure the cool air outlet temperature with an accurate thermometer. For room temperatures above 70°F (22°C), the cool air outlet temperature should be at least 10°F (6°C) colder than the air inlet temperature. In areas of high humidity or ambient temperature below 70°F (22°C), the temperature difference may be less than 10°F (6°C).
7. After completing the above check point, the Ice Qube TMS is ready to be mounted to your enclosure.

## Preparing the Enclosure

Please read entire section before beginning installation. The Ice Qube TMS has been designed to be light in weight for easy installation. Side mount units have been designed with a simple two stud alignment feature to make initial fastening to the enclosure quick and easy. A few modifications must be made to your enclosure to provide proper air flow, maintain enclosure integrity, and assure secure installation. Required modifications will vary with Ice Qube TMS model.

1. Ensure the mounting surface and enclosure will support the weight of the Ice Qube TMS and will not become unstable causing bodily harm or equipment damage. For units mounted on enclosure doors, confirm hinges will support the weight of the Ice Qube TMS. Refer to individual specification drawings for model weights.
2. Using the specification drawing, determine the ideal location to install the Ice Qube TMS on your enclosure.
3. Upon deciding the installation location of the Ice Qube TMS on your enclosure, use the cutout drawing to determine the necessary modifications to your enclosure surface needed to accommodate mounting of the Ice Qube TMS. An Electronic copy is available at <http://www.icecube.com/downloads/specification-drawings/>
4. Ensure the Ice Qube TMS will be mounted level.
5. Ensure the inlet and outlet of the cold air stream will not be restricted by equipment or shelving within your enclosure.
6. Check that the air flow of the warm air stream will not be affected or restricted.
7. Confirm the gasket is properly installed to the Ice Qube TMS. This gasket is required to create a seal against your enclosure and will maintain enclosure integrity. (See Figure 11 pg:21 and Figure 12 pg:22)

## Mechanical Installation Instruction

**Caution: Protective safety clothing such as helmet, gloves, and steel toe shoes are recommended.**

1. Position the Ice Qube TMS so that the two mounting studs are in alignment with the top two 1/2" (12.7mm) holes in your enclosure surface. (See Figure 1: Enclosure Installation pg:7)
2. Slide the Ice Qube TMS mounting studs through the 1/2" (12.7mm) holes in your enclosure and check to see that all openings are aligned.
3. After checking that all opening and bolt holes are in alignment, assemble and tighten the (2) M10-1.5 nuts and (8) M6-1 x 20mm bolts supplied with you Ice Qube TMS by hand. Check to ensure gasket will properly seal the Ice Qube TMS to your enclosure.
4. Using a wrench, tighten the nuts and bolts until the gasket between the air conditioner and the enclosure is compressed to a maximum thickness of 1/8" (3.175mm). Check the entire perimeter of the gasket/enclosure interface for compression and seal.
5. Models that require maintaining a positive purge pressure or closed loop will require the condensate trap to be filled. Carefully and slowly pour 20.0 ounces (600mL) of clean water into the drain pan located on the rear of the unit. Look for label marking. Some water may drain from the condensate overflow nipple on the side of the unit during this procedure.
6. Mechanical installation is now complete. Continue with the electrical installation of the Ice Qube TMS.
7. Connect external M6-1 x 20mm cabinet ground stud to secure earth ground (nut and wire terminal are provided).

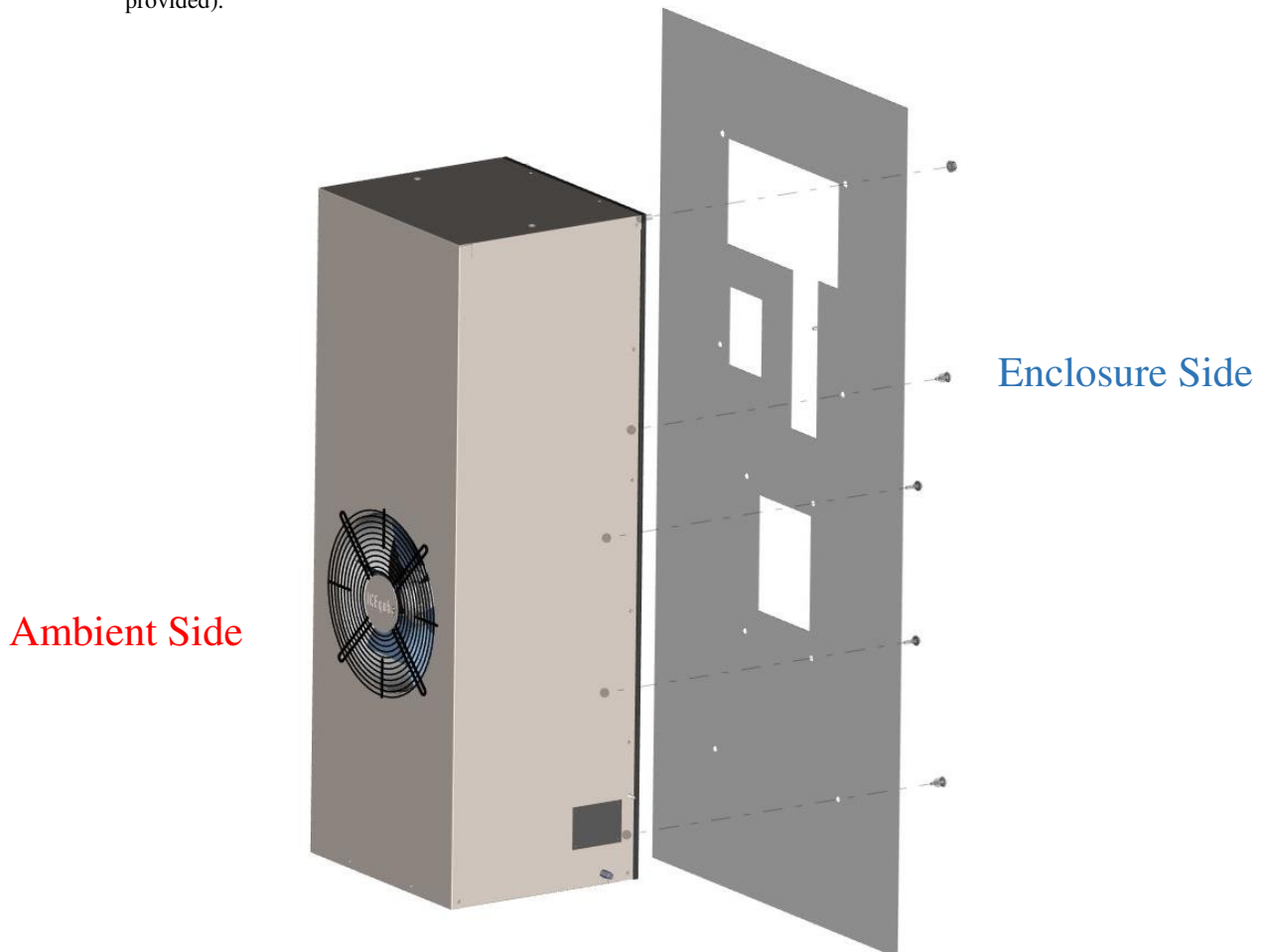

Figure 1: Enclosure Installation

## Electrical Installation Instruction

Please read the entire section before beginning the electrical installation of the Ice Qube TMS. Ice Qube air conditioners have been designed for easy electrical power connection at one specific location on the enclosure side of the Ice Qube TMS. Each Ice Qube TMS has been designed to operate at a range of voltages and frequencies. See unit label(s) for correct voltage and frequency for your model(s).

### **\*\*\*WARNING: ELECTRICAL SHOCK AND EXPLOSION HAZARD\*\*\***

**Electrical connections should only be completed by a qualified technician. Compliance with all safety and electrical codes are required. Contact local authority having jurisdiction as required. Do not connect while the circuit is energized. Turn off circuit breaker and install lock out. The area is to be free of ignitable concentration of gases.**

#### Pre-Installation Checks

1. Check the air conditioner model label or specification for power requirements.
2. Check the designated air conditioner power supply for adequate and proper electrical power requirements.
3. Check that wire routing to the terminal box will not interfere with or become damaged by other components.

#### Electrical Installation

1. Check that the air conditioner designated power supply is de-energized and locked out.
2. Locate customer interface electrical junction box on enclosure side of air conditioner. (See Figure 3: Customer Interface pg:9).
3. Remove the (4) terminal box cover screws and remove the cover. (See Figure 2: Customer Wiring pg:9). The terminal block will be used for power.
4. Loosen bottom nut of gland on the right side of the junction box to allow for cable entry. Power cable must be selected to meet power requirements of installed model and provide seal in the 20mm cable gland. Recommended conductor size is 14AWG. Cable type should be a flexible conduit that is effectively clamped to prevent twisting and pulling.
5. Remove outer jacket from cable to allow sufficient length of the three conductor wire for attachment to terminal blocks inside the junction box.
6. Strip inner jacket of the wires a length of 10mm. Remove any clear plastic coating.
7. Insert wires into the terminal blocks as shown, Line1, Line 2, and Ground. After inserting wire, tighten terminal block screws. Check that wires are secure in terminal block and are connected to the correct terminals (See Figure 2: Customer Wiring pg:9)
8. Position power cable so that the cable outer jacket will form a seal in the cable gland.
9. Tighten bottom nut of gland until resistance is felt on the power cable.
10. Carefully position wires inside the junction box so they will not interfere with cover replacement.
11. Reinstall the junction box with the 4 screws using a crossing pattern.
12. The system is now ready for operation.



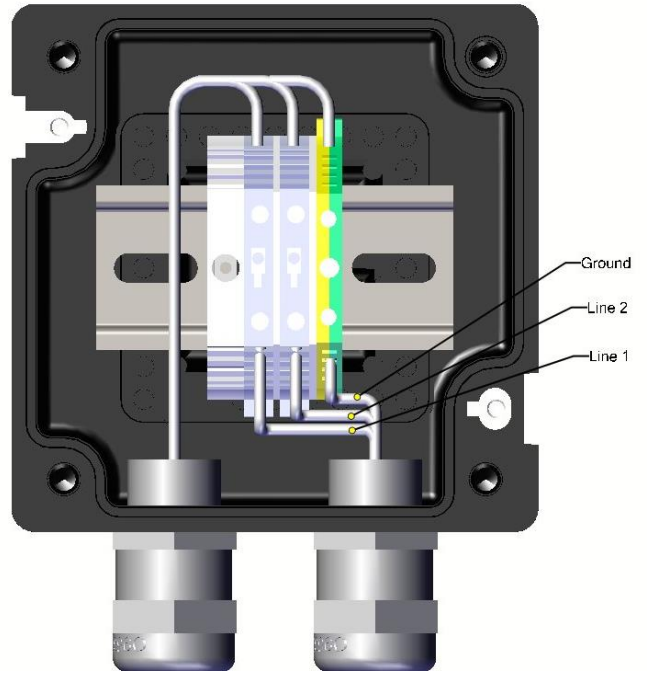

Figure 2: Customer Wiring

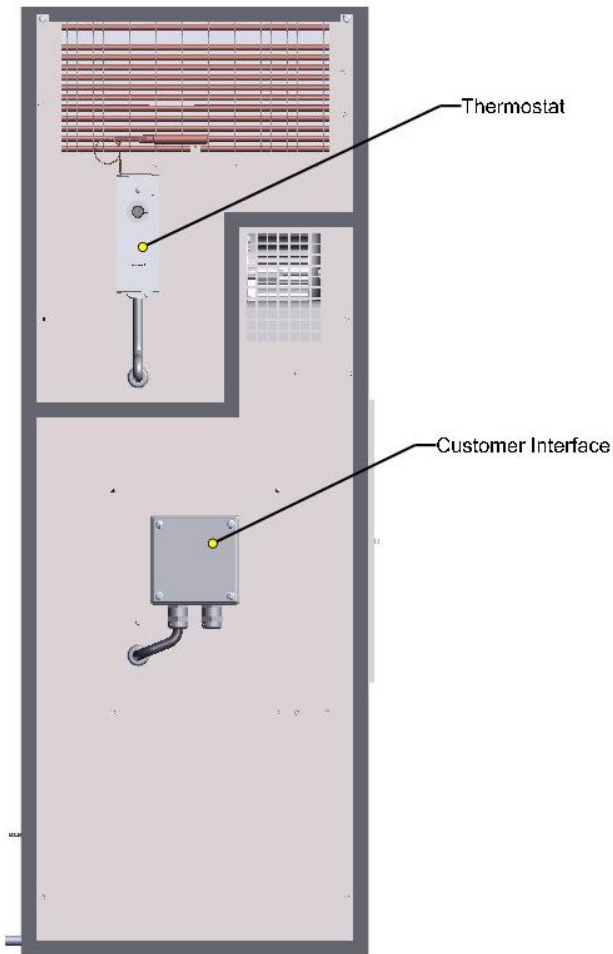

Figure 3: Customer Interface

## Operating Your System

Once the Ice Qube TMS has been installed onto the enclosure and the power cable has been attached to a properly grounded electrical connection with adequate voltage and current supply, the unit is ready for operation. As soon as electrical power is supplied to the Ice Qube TMS, the air conditioner will begin to operate.

On the rear or enclosure side of the cooling system is the thermostat. The thermostat is responsible for control and operation of the vapor-compression refrigeration system and air movers. When power is supplied to the system, the cooling system will begin to operate if the temperature is at or above the set point of the thermostat. At this set point temperature, the cold and warm air movers, along with the compressor will begin operation. As the temperature inside the enclosure cools to the thermostat off temperature, the thermostat will signal the compressor and air movers to stop operation.

### Thermostat Operation

The purpose of the thermostat (T675A) is to cycle on and off the cooling system as required from the heat produced by the equipment within the enclosure to prevent heat fatigue thus extending the life of the electronic equipment. The thermostat is located on the enclosure side of the air conditioner below the warm air return. The thermostat temperature sensing bulb is located in the warm stream of air returning to the air conditioner from the enclosure.

On the face of the thermostat, you will see an adjustment knob within a temperature range of -15 to 35°C (5 to 95°F). To adjust the operating temperature of the thermostat, gently turn the knob until the pointer is aligned with the desired temperature of the enclosure. This is the temperature at which the cooling system will begin cooling.

The thermostat has a factory set differential of 2.8°C (5°F). The unit will stop cooling when the enclosure temperature is 2.8°C (5°F) below the cooling on setting, indicated by the pointer. The unit will automatically begin to cool again when the internal temperature of the enclosure reaches the cooling on set point.

Ex:	Set Point	25° C (77° F)	Cooling on temperature
		22.2° C (72° F)	Cooling off temperature

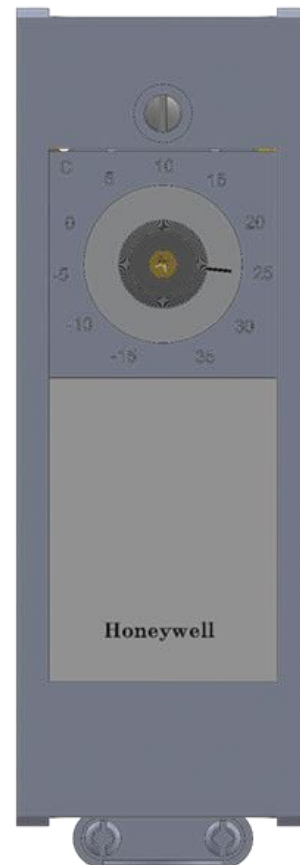



## Service and Maintenance Instruction



**\*\*\*WARNING: EXPLOSION HAZARD!\*\*\***

**DO NOT SERVICE OR MAINTAIN THIS PRODUCT WHILE CIRCUIT IS ENERGIZED!**

### Service

**Caution: Service to this model may void the hazardous area ATEX / IECEx Certification and factory warranty. Please contact Ice Qube with any questions regarding service before opening or altering the system from its original factory configuration.**

### Maintenance

The Ice Qube air conditioning system should provide many years of trouble-free operation with a minimal amount of maintenance. Primary maintenance consists of the ambient air filter(s) condition and condensate management drain nipple.

1. Ambient Air Filter - The purpose of the filter is to prevent debris in the air from fouling the condenser coil. The ambient air filter(s) should be checked and cleaned regularly to assure the cooling system is operating at peak performance. Filter maintenance schedule is dependent upon ambient air conditions. To check the condition of the air filter, it is recommended to first remove electrical power from the Ice Qube cooling system. Next, locate the filter rack(s) and filter(s). Location varies with model. Remove the filter(s) by grasping the pull tab and sliding from the filter rack. Cleaning methods will be determined by type of debris trapped by the filter. Dry type of debris may typically be removed with the use of compressed air, blowing in the opposite direction of the air movement through the filter as when the filter is installed. Adhering type of debris may be removed by soaking the filter in a mild detergent solution, then rinsing in clean water. A wet/dry vacuum may be used to remove excess water from the filter before re-installing into the filter rack. Replace the filter if it is showing signs of deterioration.

**Note: It is recommended to have a spare clean filter in stock in order to prevent prolonged cooling system downtime. The fouled filter may be cleaned at a more convenient time.**

2. Condensate Management Drain Nipple - The condensate management system nipple should be checked periodically for scale, sludge and debris that may cause the inside of the nipple to become blocked. The type of environment will determine the frequency of required maintenance. Nipples may be cleaned using a 6 mm (1/4") inch soft bristle tubing brush.
3. Occasionally, it may be necessary to clean the air conditioner components or cabinet. To clean the system cabinet, simply wipe it with a damp, lint free cloth. A mild soap solution may be used if necessary.

### PRECAUTIONS TO AVOID ELECTRICAL SHOCK HAZARD:

- A. Do not clean while electrical circuit is energized.
- B. Surfaces are to be cleaned only with a **damp cloth** to avoid build-up of electrostatic charge.

**WARNING: REMOVAL OF TMS COVER WILL IMMEDIATELY VOID YOUR WARRANTY!**

## Trouble Shooting

Contact Ice Qube if the air conditioning system should fail to operate satisfactorily during the first year of operation. DO NOT remove the cover without first notifying customer service. **Removal of the cover will immediately void the warranty.**

If an operating problem should occur, please review the items outlined on the following page “Trouble Shooting Check List.” If the problem persists, obtain model and serial number before contacting Ice Qube for technical assistance.

## Trouble Shooting Checklist

<b>Model No:</b>		<b>Serial Number:</b>	
<b>Voltage Rating:</b>	<b>Amps:</b>	<b>Phase: 1</b>	<b>Frequency:</b>
<b>Options:</b>			
Is proper electrical power available at the power supply?	Yes <input type="checkbox"/>	No <input type="checkbox"/>	
Is your power cord connected to the power supply and IQ terminal block?	Yes <input type="checkbox"/>	No <input type="checkbox"/>	
Is the thermostat set-point temperature below the enclosure temperature?	Yes <input type="checkbox"/>	No <input type="checkbox"/>	
Is the evaporator (cold air stream) blower operating?	Yes <input type="checkbox"/>	No <input type="checkbox"/>	
Is the compressor and condenser (warm air stream) blower operating?	Yes <input type="checkbox"/>	No <input type="checkbox"/>	
Is the enclosure door closed tightly?	Yes <input type="checkbox"/>	No <input type="checkbox"/>	
Are all of the gaskets in place?	Yes <input type="checkbox"/>	No <input type="checkbox"/>	
Has the condenser (warm air stream) filter been cleaned or changed recently?	Yes <input type="checkbox"/>	No <input type="checkbox"/>	
Is the system mounted level on the enclosure?	Yes <input type="checkbox"/>	No <input type="checkbox"/>	
Is there adequate space within the enclosure for air flow?	Yes <input type="checkbox"/>	No <input type="checkbox"/>	
Is there adequate space around the air conditioner for airflow?	Yes <input type="checkbox"/>	No <input type="checkbox"/>	
Has the enclosure population remained the same?	Yes <input type="checkbox"/>	No <input type="checkbox"/>	
Notes:			

For additional support call:

Ice Qube at 1-888-867-8234

Please have above checklist completed before you call.

**Schematic Wiring Diagrams**

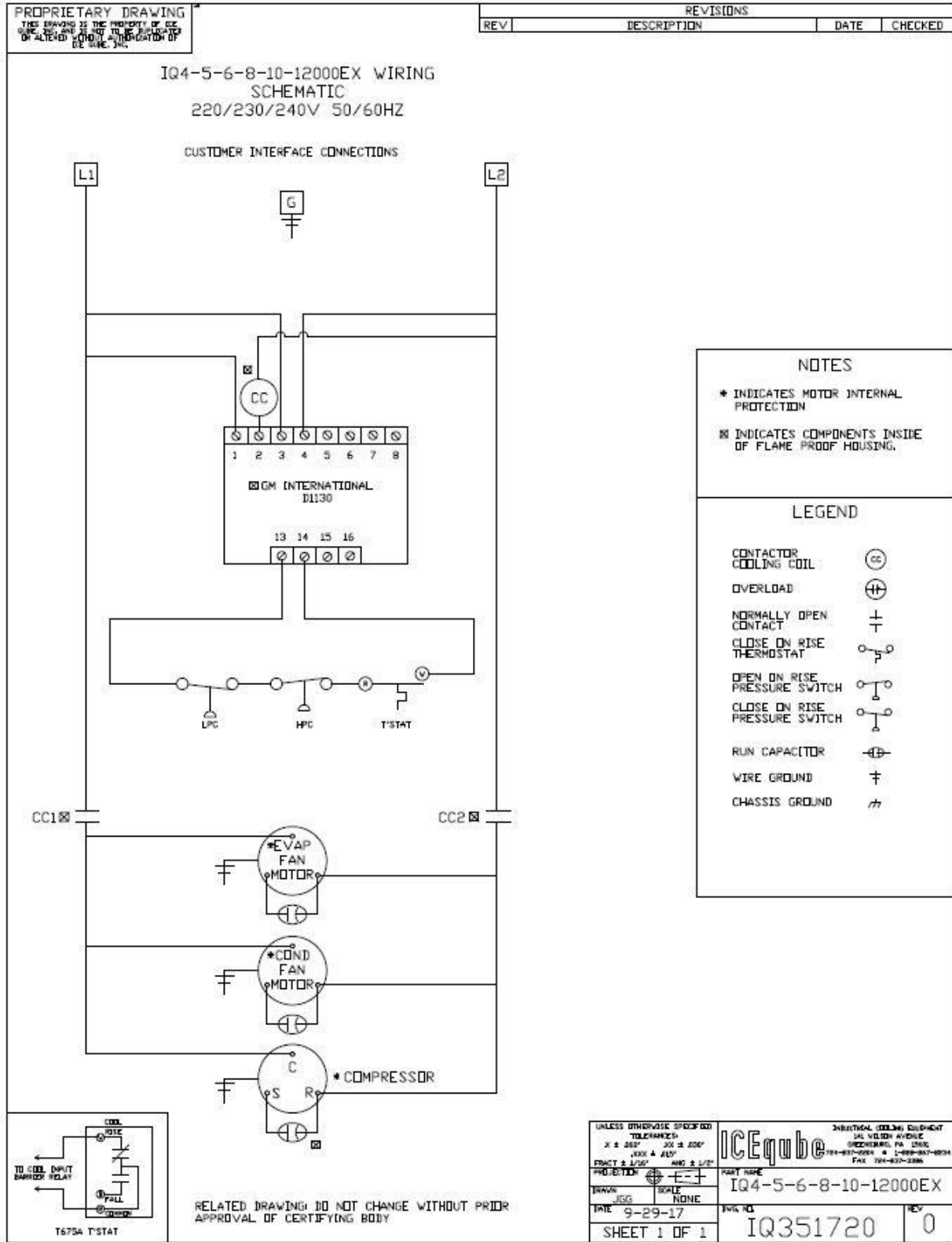

Figure 4

# Specification Drawing

## IQ4000EX

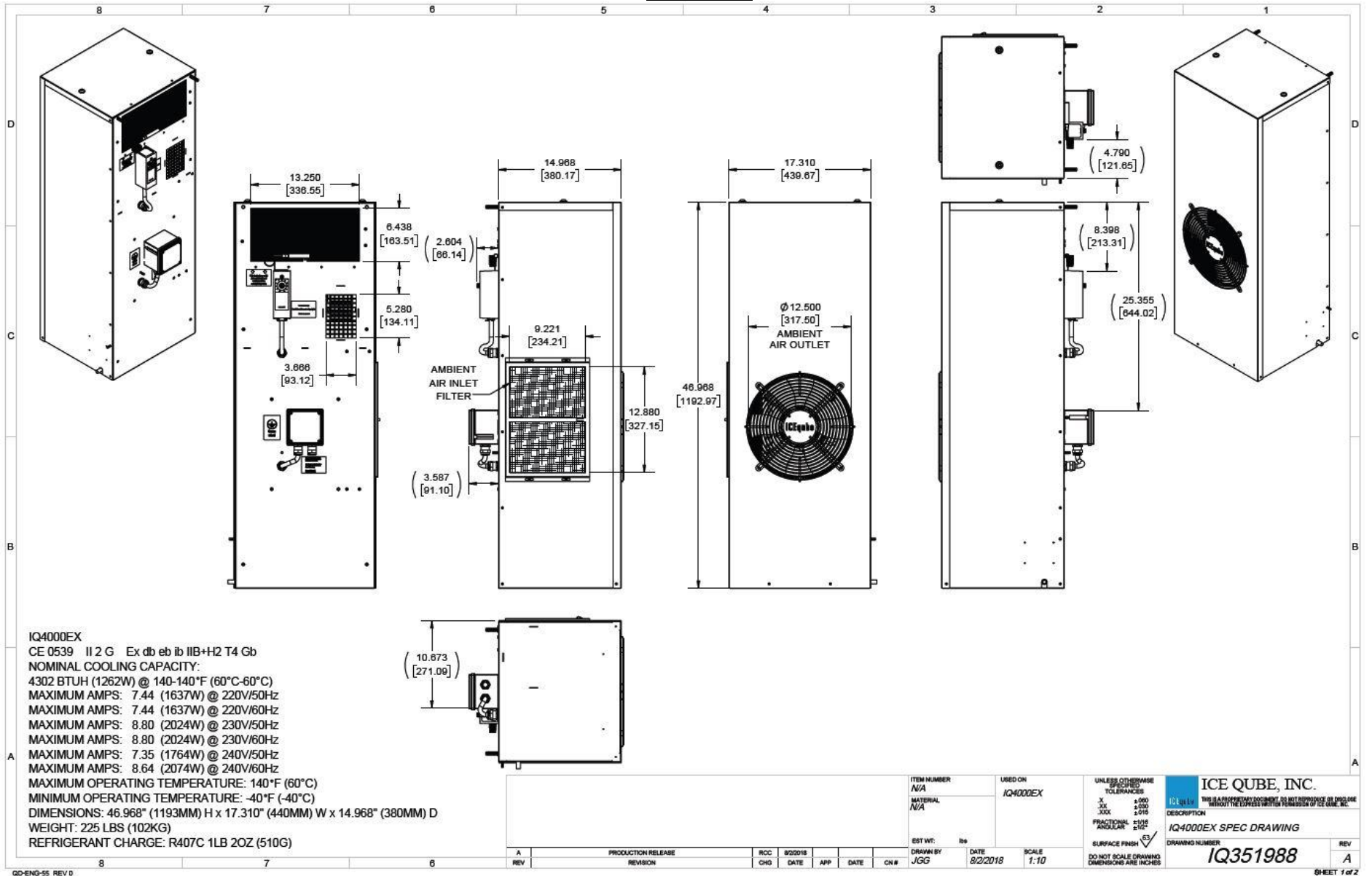

Figure 5

# IQ5000EX

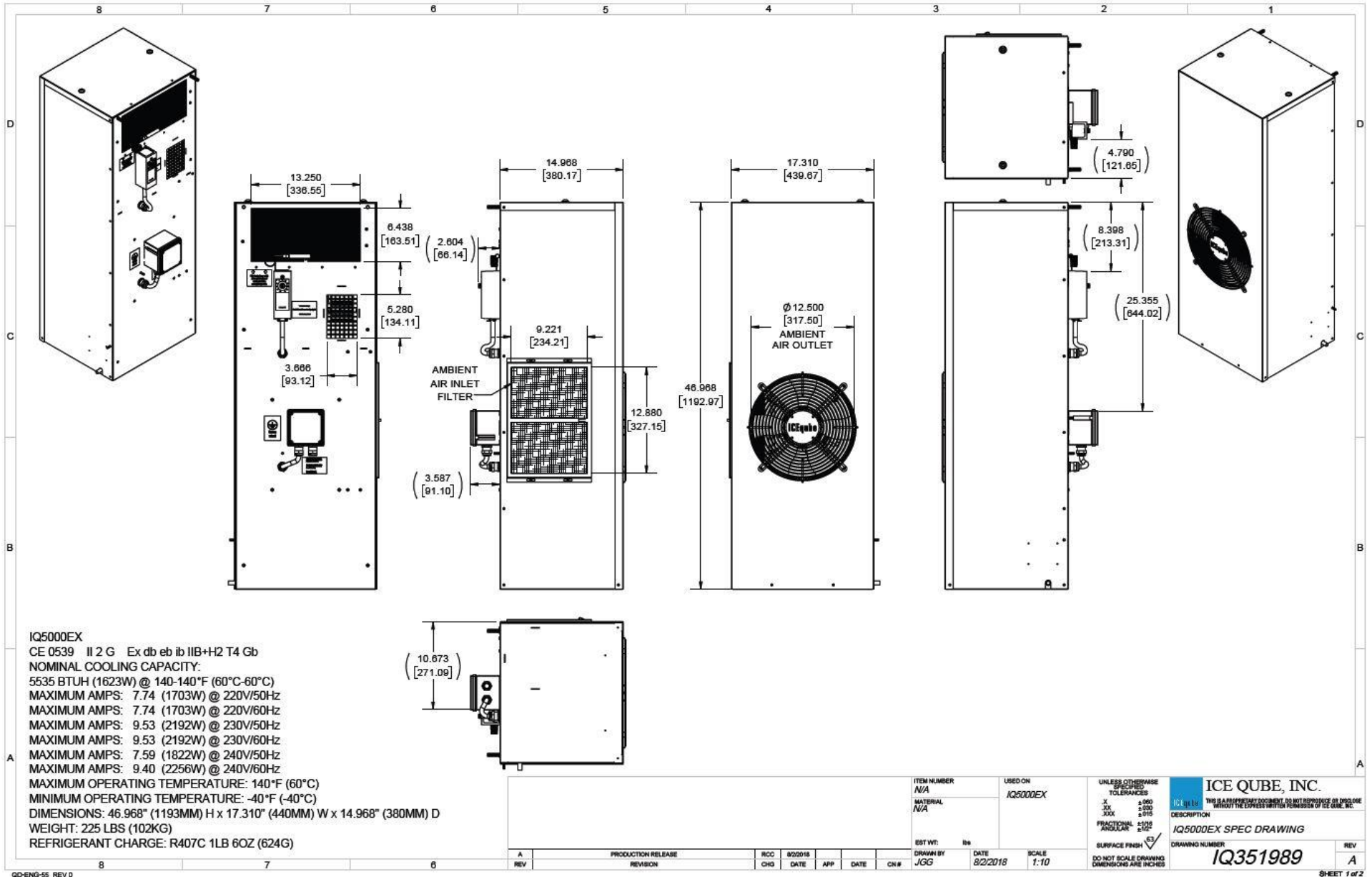

Figure 6



# IQ6000EX

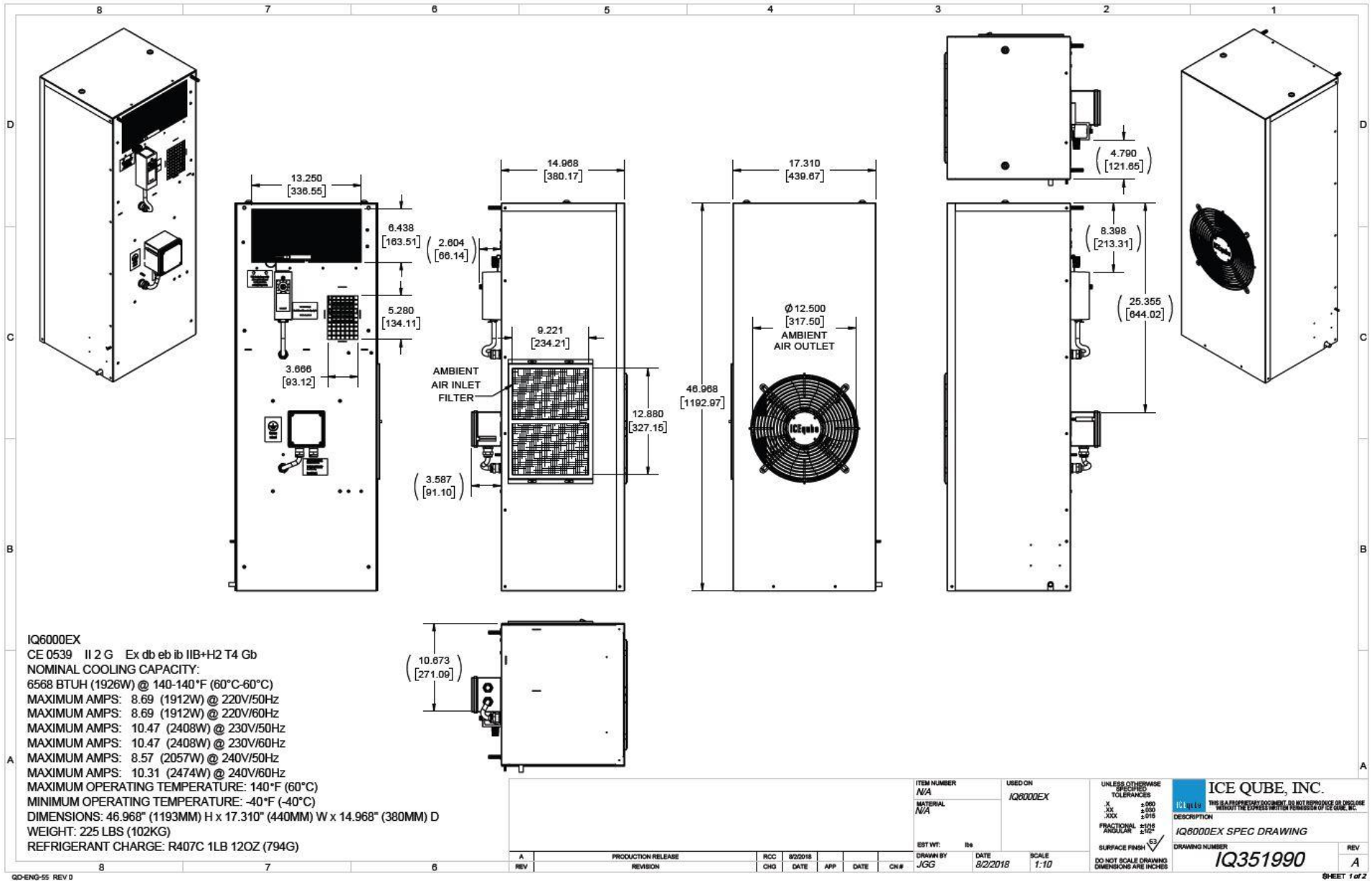

Figure 7

# IQ8000EX

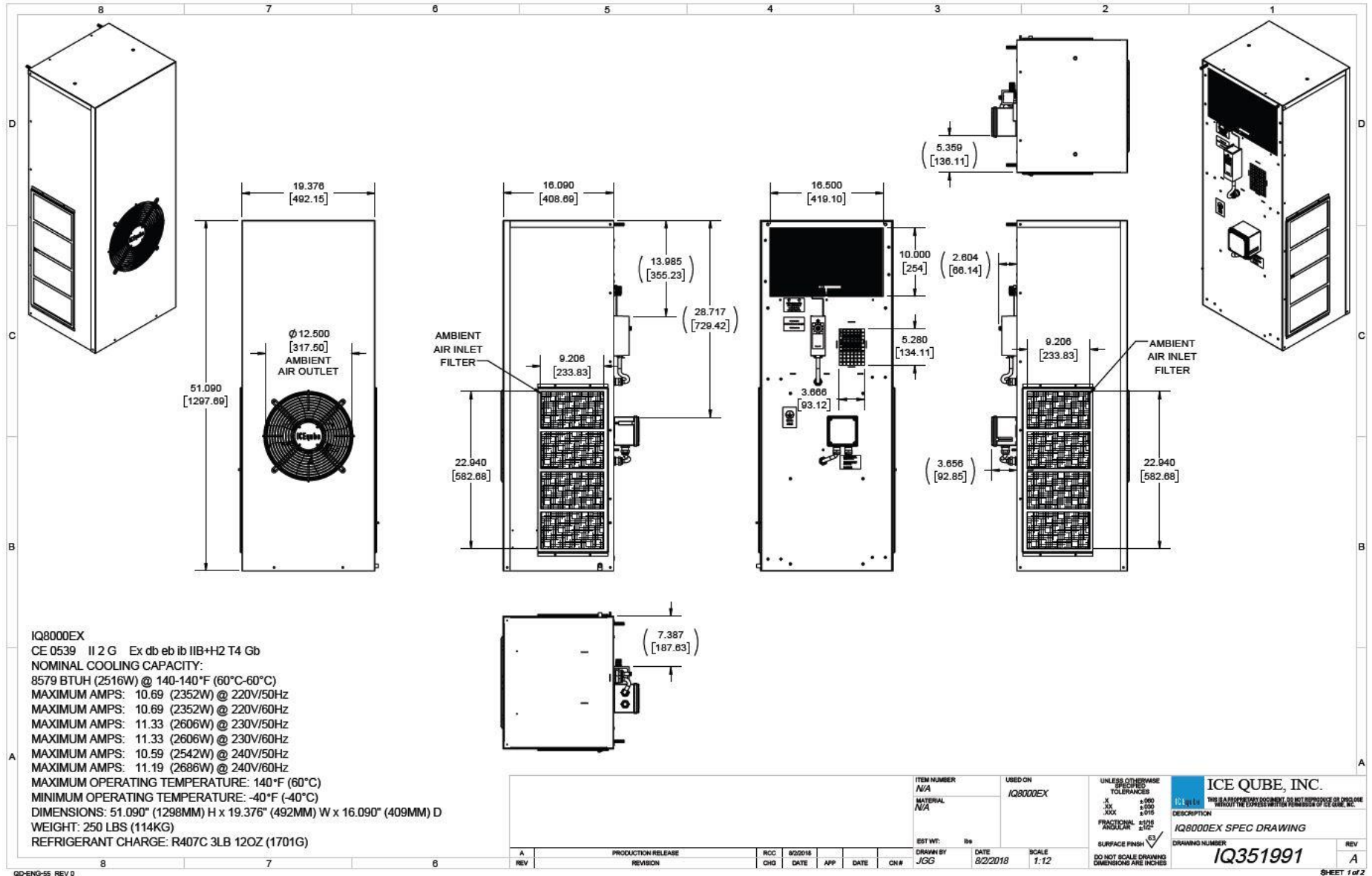

Figure 8

# IQ10000EX

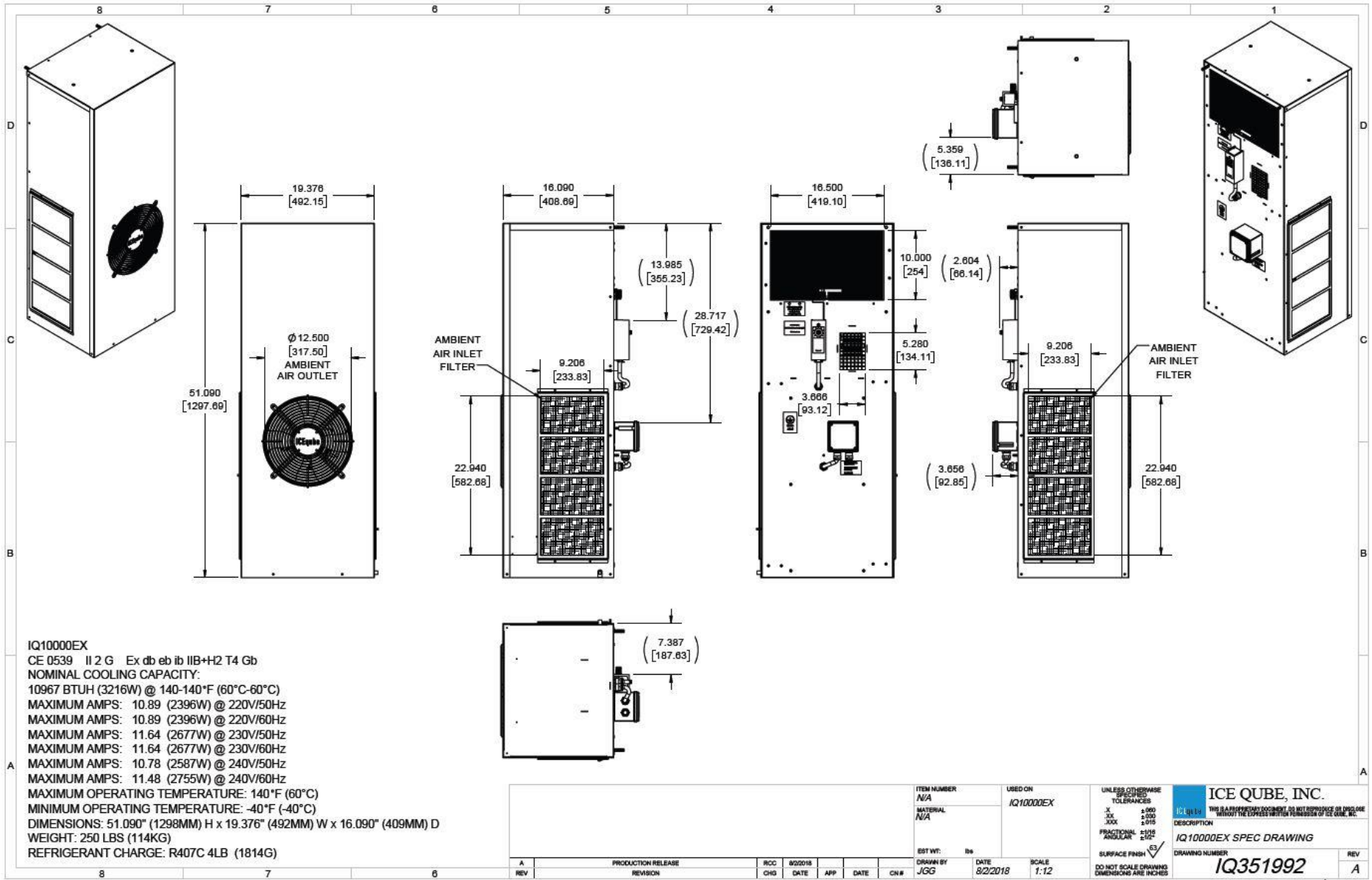

Figure 9

# IQ12000EX

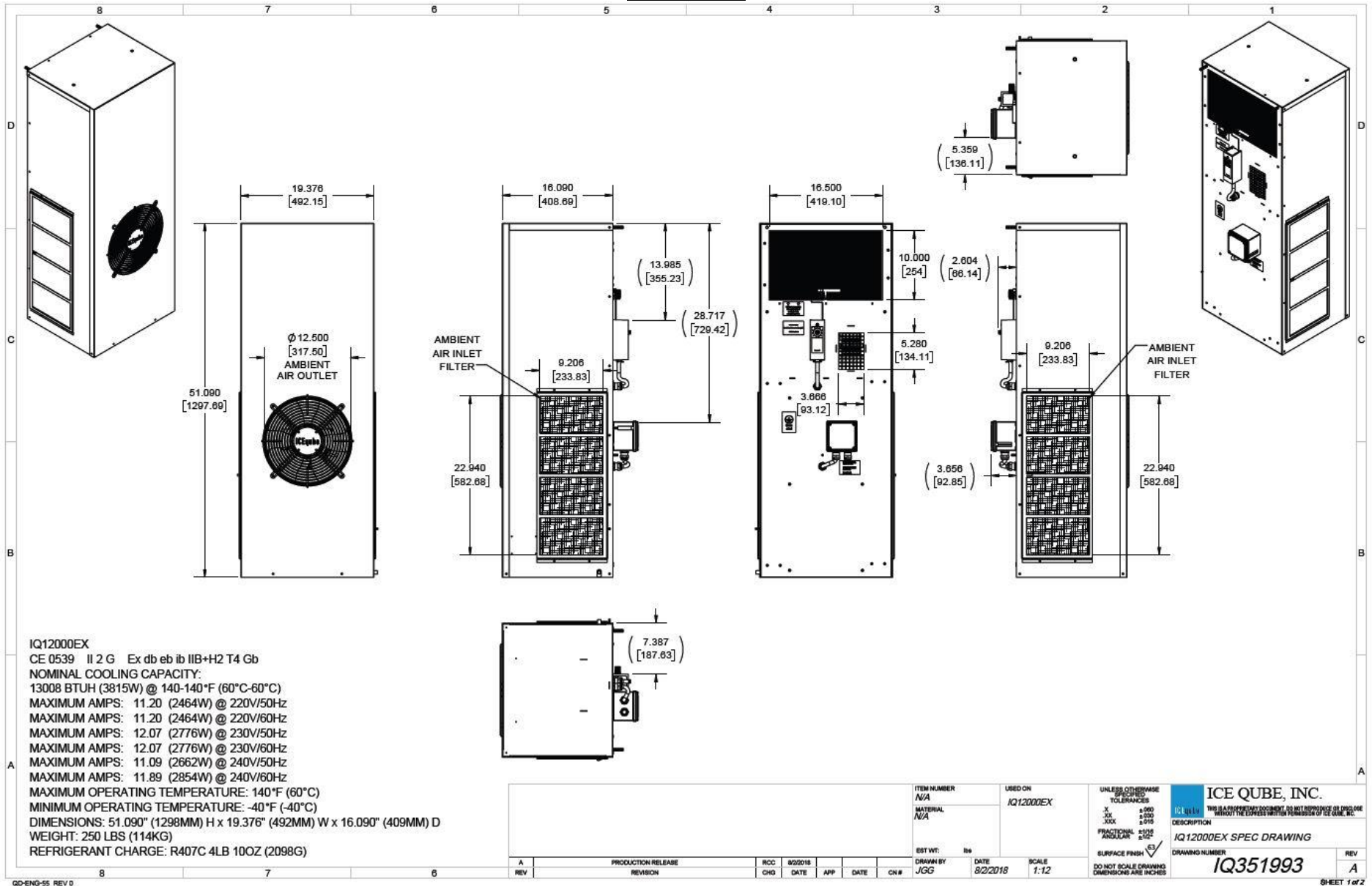

Figure 10

# IQ4-5-6000EX Gasket and Cutout

Same Gasket and Cutout for IQ4000EX, IQ5000EX, and IQ6000EX

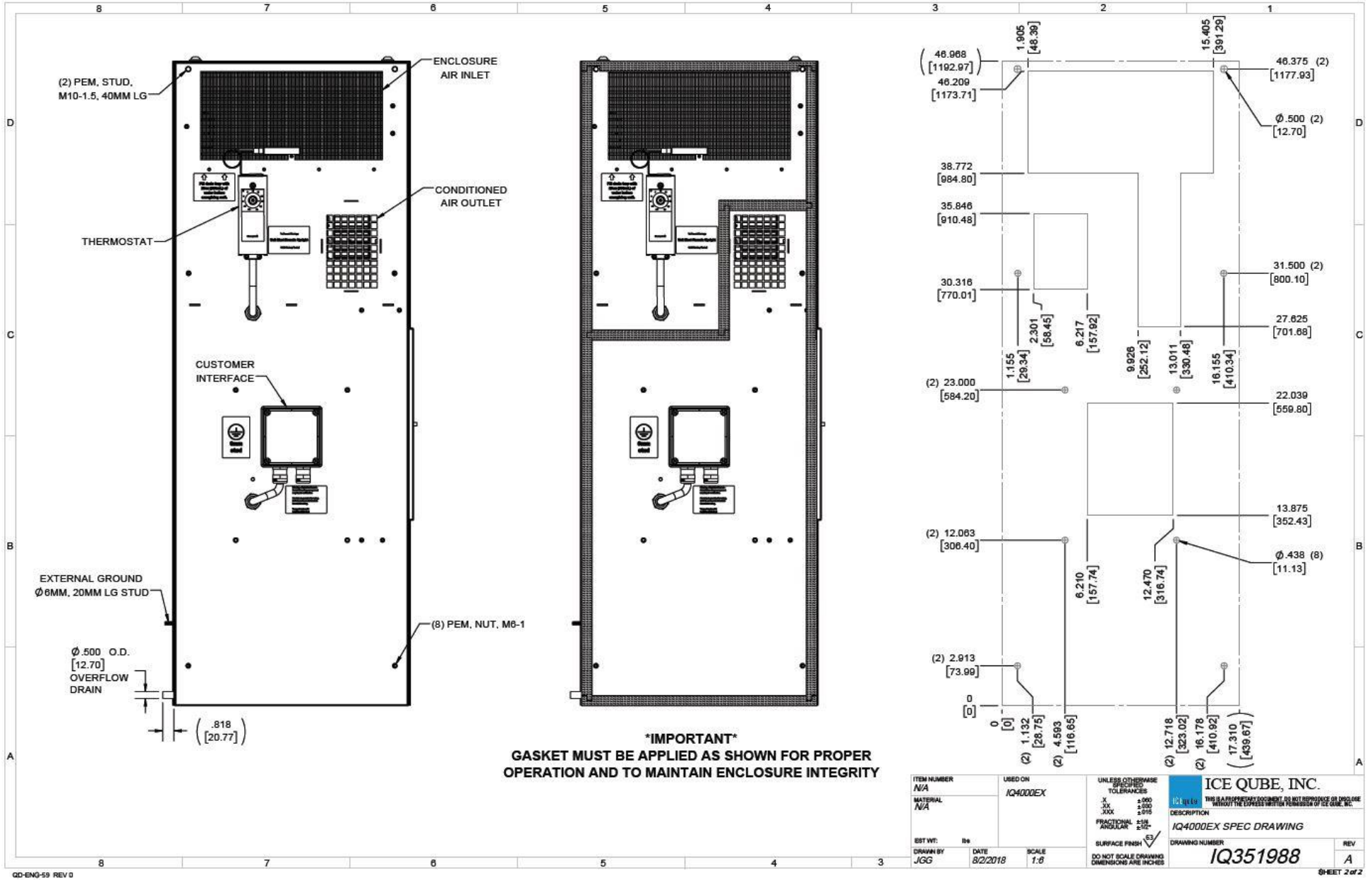

Figure 11

# IQ8-10-12000EX Gasket and Cutout

Same Gasket and Cutout for IQ8000EX, IQ10000EX, and IQ12000EX

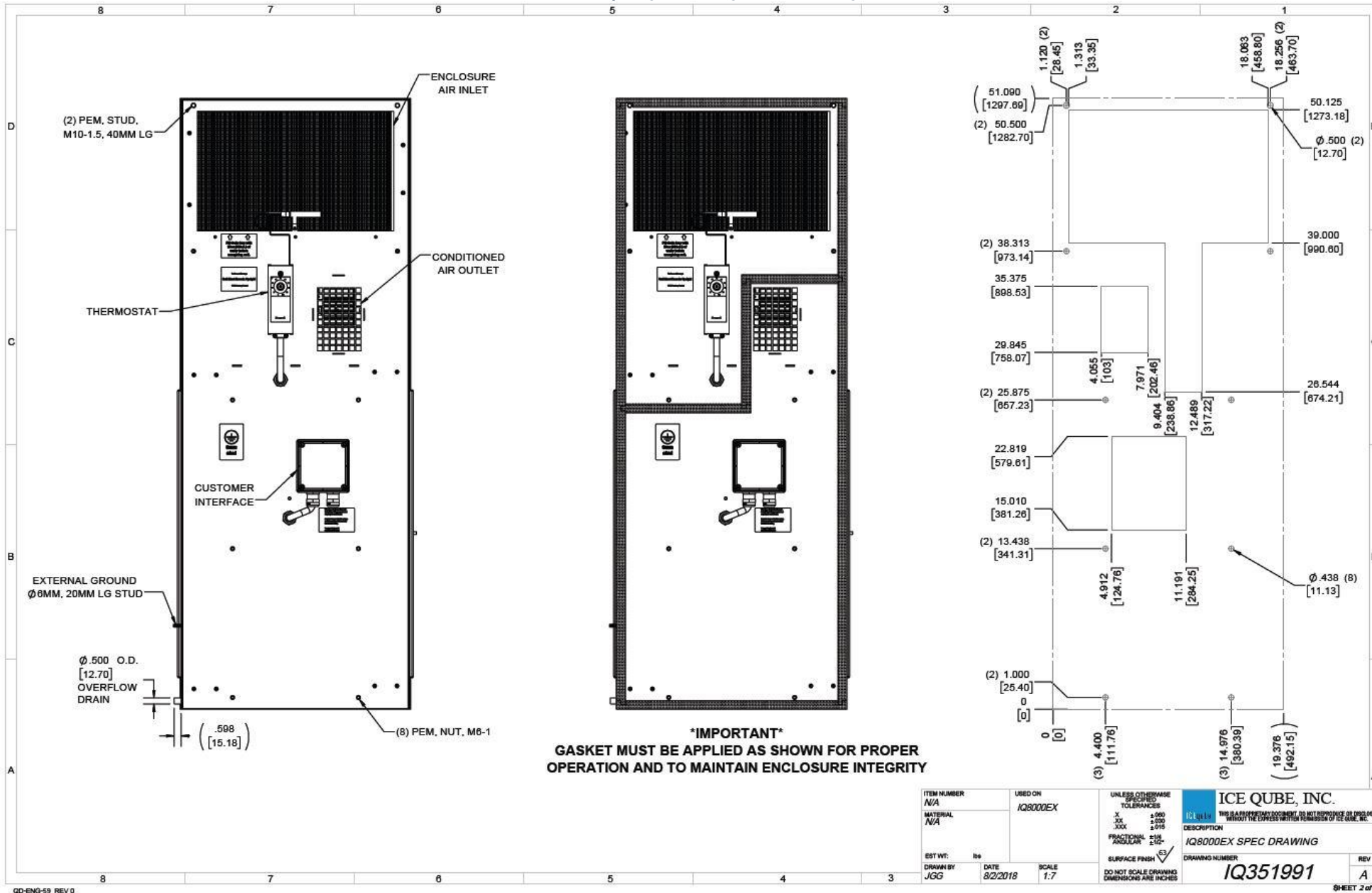

Figure 12



**Standard Warranty Policy**

Ice Qube, Inc. ("**Ice Qube**") warrants that the products manufactured by Ice Qube (the "**Products**") are free of defects in material and workmanship which impair the operation of the Products, under normal and proper use and service, for a period of one (1) year from the date of shipment FCA from Ice Qube's facility located in Greensburg, Pennsylvania (the "**Standard Warranty**").

In order for this Standard Warranty to apply, the Product(s) must be installed and operated according to and consistent with the following conditions:

- Operation within the rated voltage on the label of the Product;
- Frequency variation no greater than +/- 3 HZ from rated frequency on the label of the Product;
- Ambient temperature must not exceed operating temperature range on the label of the Product;
- Maximum cooling capacity not to exceed rating (BTU/HR) as rated on the label of the Product; and
- The Product must be installed, maintained and operated consistent with the terms and conditions set forth in the operation manual.

**THIS STANDARD WARRANTY DOES NOT COVER THE FOLLOWING:**

- Ice Qube assumes no liability beyond the repair or replacement of its own Products. In no event shall Ice Qube be liable for any incidental, special, indirect, consequential or similar damages incurred by any purchaser, owner, possessor, assignee or successor in interest or any other third party having any interest in any Product as the result of any breach of this Standard Warranty, including but not limited to loss of profit or revenues, damages for loss of use of the Products, damage to property, both real and personal, claims of third parties, including personal injury or death on account of use of the Products or failure of Ice Qube to warn against or instruct on or adequately warn against or instruct on, the dangers of the Products or the safe and proper use of the Products, whether or not customer has been advised of the potential for such damages.
- Ice Qube's total liability for customer's claims from any cause whatsoever, whether arising under contract, warranty, tort (including negligence), strict liability, products liability or any other theory of liability, will be limited to the lesser of customer's actual damages or the price paid by customer to Ice Qube for the Products (not including applicable taxes, duties and freight charges) that are the subject of customer's claim.

THE WARRANTY SET FORTH HEREIN IS STRICTLY LIMITED TO ITS TERMS AND IS IN LIEU OF ALL OTHER WARRANTIES, GUARANTEES, EXPRESS OR IMPLIED, ARISING BY OPERATION OF LAW, COURSE OF DEALING, CUSTOM, USAGE OF TRADE OR OTHERWISE, SPECIFICALLY EXCLUDING ANY IMPLIED WARRANTIES OF MERCHANTABILITY OR FITNESS FOR A PARTICULAR PURPOSE OR USE.

1. The warranty and remedies for breach of warranty provided for in this Standard Warranty extend only to the original installation and do not cover, and Ice Qube will neither assume responsibility, nor be liable, for the following:
  - misapplication of its Products or the erroneous selection of an inappropriate Product by a non-authorized Ice Qube representative;
  - use of the Product for other than its designed purpose or operating conditions;
  - operation or storage in harsh, oily, corrosive or other abnormal environments without the proper filtration, sealing, protective coatings and/or weather protection;
  - damage to the hermetic system resulting from continuous operation with dirty or clogged air filters or improper or negligent maintenance;
  - use of refrigerant other than designated on the label of the Product;
  - customer modification or abuse;
  - shipping damage or other accidental damage (It is Ice Qube's standard policy that freight claims are the responsibility of the customer if the Product is not refused at delivery);
  - repair, damage or service of the Product caused by anyone except personnel authorized by Ice Qube;
  - cracked or broken hermetic tubing, brazed joints or other internal damage caused by shipping or mishandling;
  - damage caused by shipping units attached to an enclosure;
  - any and all damage, breakage, malfunction or other like conditions or defects resulting from noncompliance with the standard operation, care, installation, maintenance and use of the Product as set forth in the operation manual for such Product;
  - any cause beyond the control of Ice Qube, including without limitation conditions caused by movement, settlement or structural defects of the environment in which the Products are installed;



- fire, wind, hail, flood, lightning or other acts of God;
  - any damage to the finish of the Products after they leave Ice Qube's facility;
  - any discoloration or spotty appearance of the Products;
  - return freight and shipping charges, along with applicable duties and other like fees and charges, for the return of the Product to Ice Qube (such amounts are the sole responsibility of the customer);
  - failure to process or inaccurate processing of time-sensitive information and/or mechanisms; or
  - Exposure to harmful chemicals, pollutants or other foreign matter or energy.
2. All returns must have a RMA number and must be marked with the RMA number on the bill of lading and on the packaging.
  3. Upon resale, customer agrees to extend to its customers no greater warranties, and limit its liability and remedies to the same extent, as those set forth herein.
  4. All Product literature is for illustrative purposes only and does not contain a warranty of any kind.
  5. Ice Qube's advice relating to the technical usage of the Products or the intellectual property rights of others, whether provided orally or in writing or through the provision of test results, is given in accordance with Ice Qube's best knowledge at that time, but shall at all times be deemed to be non-binding. Such advice does not relieve customer from the obligation, and customer accepts full responsibility, to confirm for itself the suitability of the Products for their intended purpose(s).

#### **Remedies**

Customer's sole and exclusive remedy, and Ice Qube's only obligation for breach of warranty hereunder shall be, at Ice Qube's option, in its sole discretion, to (i) repair or replace the defective Product which fails within the one (1) year warranty period, free of charge, provided that customer promptly notifies Ice Qube of such failure and, after receipt of prior written authorization and return authorization number from Ice Qube, which will be given or withheld at Ice Qube's sole discretion, returns such Product to Ice Qube, Inc., 141 Wilson Avenue, Greensburg, PA 15601, USA or such other place as requested by Ice Qube, freight prepaid, and thereupon Ice Qube finds such to be defective or (ii) issue a credit equal to the price of the defective Product which fails within the one (1) year warranty period. Customer must pay all related costs of repair or replacement, including removal, installation or reinstallation costs. Ice Qube's personnel must be granted access to inspect the Products claimed to be defective at the site of their installation or use. Products repaired or replaced and designs corrected under this Standard Warranty are warranted only for the remainder of the original warranty period.





Notes:

A large, empty grid of small squares, intended for handwritten notes or technical drawings.