



ICEcube

# Intelligent Electronic Enclosure Thermal Management Systems



## **OPERATION AND INSTALLATION MANUAL** **Blade Series and Qube Series Air Conditioning Units** **with LCD Controller**

**\*\*\* IMPORTANT \*\*\***

*PLEASE READ this manual. Follow the instructions for safe and satisfactory installation and operation of this system. Keep this manual for future reference. Some information may not apply to all systems.*

## TABLE OF CONTENTS

Introduction	Page	3
Basic operation	Page	3
Figure 1: Flow Diagram	Page	3
Unpacking Inspection	Page	4
Pre-Installation Test	Page	4
Preparing the Enclosure	Page	5
Operating the System	Page	6
Programming the Controller	Page	8
Figure 2: Digital Tap Sensitive Controller	Page	8
Alarm Operation	Page	10
Maintenance	Page	10
Troubleshooting	Page	12
Troubleshooting Check List	Page	12
Schematic Wiring Diagram		
Qube Series	Page	13
Blade Series	Page	14
Terms and Conditions/Warranty	Page	15

## INTRODUCTION:

This manual is applicable to Ice Qube Intelligent Electronic Enclosure Thermal Management Systems, controller version 1.20 (or later). Ice Qube's Thermal Management System, TMS, is designed to cool, dehumidify or heat the internal environment of modern electrical enclosures. Ice Qube offers efficient and aesthetically appealing packages that can be mounted on top or on the side of your enclosure. Our closed-loop circulation design protects your equipment from air-borne dust and contaminants which may hinder equipment operations, causing unnecessary down time. Ice Qube is able to provide cooling capacities from 1000 to 27,000 BTU per hour - a wide range of cooling systems to satisfy many of your conditioning needs.

## BASIC OPERATION:

The Ice Qube's Thermal Management System, TMS, is actually a combination of three independent systems which function simultaneously to maintain environmentally friendly conditions for various types of electronic equipment enclosures. These three thermal related systems are: the closed-loop cool air system; the warm air system; and the vapor-compression refrigeration system. Please refer to Figure 1.

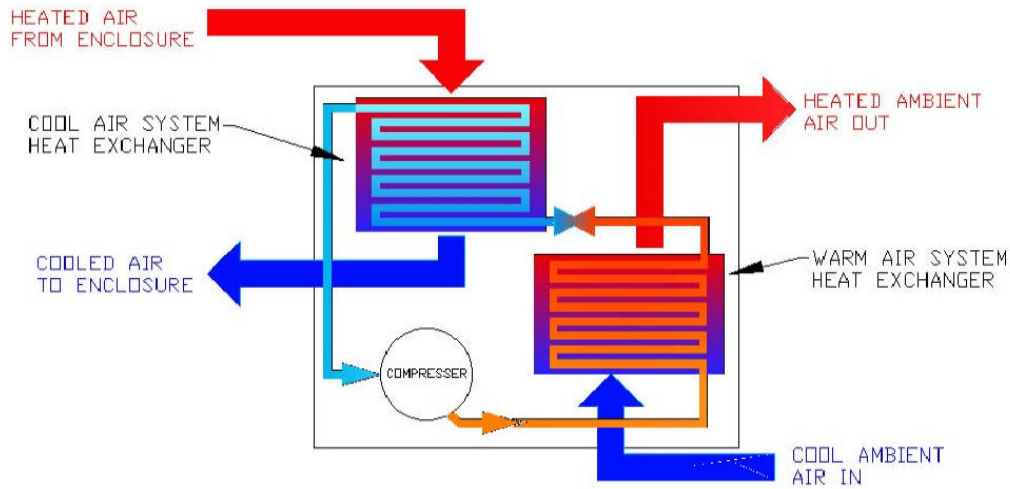

Figure 1: Flow Diagram

The closed-loop cool air system circulates cold air from the Ice Qube TMS to the electronics enclosure. This air returns to the Ice Qube system bringing with it unwanted heat and humidity from inside the enclosure. Heat and humidity is then removed by a heat exchanger located within the Ice Qube TMS. This heat exchanger is part of the vapor-compression refrigeration system.

At the heart of the vapor-compression refrigeration's system is a quiet, energy efficient rotary compressor which circulates environmentally friendly NON-CFC refrigerant. The main purpose of this compressor is to transfer heat laden refrigerant from the evaporator, located within the closed-loop cool air system, to a condenser, located in the warm air system. In the warm air system, air is circulated from the ambient surrounding the enclosure, through a filter, and across the warm air system heat exchanger. Here, heat from the enclosure is transferred from the warm air heat exchanger into the warm air stream and dissipated to the ambient.

## UNPACKING INSPECTION:

1. The shipping container leaves the factory banded to a pallet with arrows imprinted on the box. These arrows should be pointing in the proper (upward) direction. **The Ice Qube TMS is position sensitive and should remain in an upright direction at all times.** Ice Qube recommends the unit to remain in the proper upright position for a minimum of 24 hours before initial operation. This is to ensure the oil has returned to the compressor. Operation before the 24 hour time period may cause damage to the compressor, hence shortening the life of the system. If the Ice Qube air conditioner should arrive *not* banded to a pallet or *not* in the proper upright position with arrows pointing upward, the shipment may have been damaged and you may wish to consider contacting the freight carrier for instructions on filing a claim.

**NOTE:** *Operating the unit before maintaining an upright position for 24 hours will void all warranties.*

2. Check for any damage to the shipping container. If the shipping container has been damaged or marred in any way, carefully check to see if the Ice Qube TMS incurred any damage. Check for scratches, dents, rattles (which may indicate loose components), the presence of oil, and any other irregularities. Any evidence of damage will need to be recorded on the freight bill and reported to the carrier. The freight carrier will provide instructions on filing a claim. **Ice Qube cannot accept responsibility for damages that occur during shipping.**

## PRE-INSTALLATION TEST:

Before installing the Ice Qube system on the enclosure, it is recommended the unit operates for 20 to 30 minutes to ensure it is functioning properly. Although the Ice Qube TMS has been tested at the factory, internal damage may have occurred during shipping which may have not been apparent during the unpacking inspection.

1. Place the system on a solid base such as a workbench or table. Be sure to allow adequate space for airflow. There are two air streams that must not be restricted, the cool air stream and the warm air stream. If the surrounding air is humid, provide a drain line for possible condensate to avoid electrical hazards and overflow of condensate water around the Ice Qube TMS unit.
2. Check that the warm air system filter is in place, location varies with model type (optional for Blade Series).
3. Models with the optional rain or wash down hood do not have a warm air filter and may require regular routine condenser maintenance.
4. Check the data tag for proper electrical requirements. The data tag lists the design voltage and amperage requirements of the system. Verify that the electrical outlet where the system will be connected has the proper capacity. After noting the above, connect the power cord to a properly grounded electrical connection. The use of an extension cord is not recommended. Blade series air conditioners require a power cord connection to unit. This should be done by a qualified technician.

**NOTE:** *If any unusual noise or vibration is present during the testing procedure, immediately disconnect the power cord and inspect the unit for the cause of the noise or vibration. Contact Ice Qube immediately.*

5. As soon as power is supplied to the system, the controller in the system starts a self-diagnosis procedure to ensure proper operation of temperature sensors and fans. Please see steps 2 and 3 under “operating the system” for details. If the self-test procedure is performed successfully, the cool air evaporator blower will begin to operate. The compressor and warm air condenser blower will not operate if the room air temperature is below 80°F (27°C). This is due to the fact

that the programmable controller has a factory setpoint of 80°F(27°C). The digital display on the face of the controller will be displaying room temperature. If the display is indicating 80°F(27°C) or warmer, the icon  will flash on the display for 3.5 minutes before the compressor and the warm air condenser blower will operate.

If the display is indicating a temperature less than 80°F(27°C), adjust the set point to a temperature lower than the room temperature in order for the compressor and warm air condenser blower to operate. Refer to the “Programming the Controller” section of this manual in order to change the factory set points.

6. With the compressor and both blowers functioning, allow the unit to operate for 20 to 30 minutes. This will provide sufficient time for the vapor compression system to achieve equilibrium. Measure the cool air outlet temperature with an accurate thermometer. This temperature should be at least 10 degrees colder than the inlet air temperature, (if the room temperature is warmer than 70°F). Inlet air temperature will be displayed on the programmable controller. In areas of high humidity, the temperature difference may be less than 10 degrees.
7. After completing the above check points, the electrical enclosure is ready to be prepared for the installation of the Ice Qube system.

## PREPARING THE ENCLOSURE:

Ice Qube air conditioning systems have been designed to be light weight for ease of installation. Side enclosure or vertical mount units have been designed with a simple alignment feature to make initial fastening to the enclosure quick and easy. A few modifications must be made to the enclosure to provide proper airflow, to maintain enclosure integrity and to assure a safe and secure installation. Required modifications will vary with each air conditioner model.

1. Determine the location of the Ice Qube system on the enclosure.

### \*\*\* CAUTION \*\*\*

**Verify the weight of the air conditioning system will not cause the enclosure to become unbalanced. Equipment instability may cause bodily harm or equipment damage. For units mounted on enclosure doors, confirm the hinges will support the weight of the Ice Qube system. Refer to system specifications for model weights.**

2. Upon deciding the location of the Ice Qube system on the enclosure, attach the template to the enclosure surface. This template drawing will assist the installer in locating the air conditioning unit on the enclosure. Be sure that the Ice Qube system will be mounted level and the cool air inlet and outlet openings will not be restricted by equipment or shelving within the enclosure. Also check that the air flow of the warm air stream will not be effected or restricted by the surroundings.
3. Outline the modifications for the enclosure with a marking tool. Note the bolt hole locations, the cutouts for the inlet and outlet air streams, the power cord and the locations for any optional equipment. Additional cable openings may be required for units with optional heating or alarm outputs, or for units connected to a network communications link.
4. Using a drill, make the holes for the studs, bolts and any other options. The bit size will need to vary depending upon the model. **Protect any equipment located within the enclosure from debris produced during the installation procedure.**
5. Drill a pilot hole for a saber saw to cut the inlet/outlet air passages and openings for any other options. File all cuts to provide a uniform cutout.
6. Verify that all of the openings are aligned.

7. After checking that all openings and bolt holes are in alignment, apply the provided gasket material to the Ice Qube air conditioning system cabinet to ensure enclosure integrity.

**\*\*\* CAUTION \*\*\***

**Be careful while removing the backing on the gasket material. The material may stretch and the holes will not align.**

**NOTE:** *If the enclosure is not air tight or the air conditioning system operates with the enclosure door(s) open, moisture will condensate inside the air conditioning system and may cause the condensate management system to overflow.*





8. After the gasket material has been installed, mount the Ice Qube system onto the enclosure and fasten it using the supplied nuts and bolts. Check to see if the power cord and all optional cables are in place. Fasteners need to be tightened securely and the gasket material needs to be in place in order to maintain enclosure integrity. The gasket material should be compressed to approximately 1/8" thickness with no visible gaps. The Ice Qube system is now ready to begin operation.

**NOTE:** *Near the bottom or on the side of the Ice Qube system cabinet is a nipple for condensate overflow. See specifications for location. Although all vertical or side mounted Ice Qube air conditioners have built-in condensate management systems, it may be necessary to attach a drain hose to this nipple on enclosures which are located in extremely humid conditions, where enclosure doors are left open or the door seals are leaking.*

## OPERATING THE SYSTEM:



Once the Ice Qube system has been installed onto the enclosure and the power cord has been attached to a properly grounded electrical outlet with adequate voltage and current supply, the unit is ready for operation. Check model data tag for electrical requirements.

1. When connected to power the temperature controller's version number (1.20 or later) will be shown on the LCD display for two seconds.
2. The system will now start the temperature sensor detection. There are two temperature sensors in Ice Qube TMS: The temperature sensor A, placed in the evaporator section, which measures the enclosure temperature; and temperature sensor B, which is located inside the TMS cabinet (condenser section). If sensor A is abnormal, the controller will

display  +  + A + '---'; if sensor B is abnormal, it shows  +  + B + '---' and the audible alarm will also be activated.

3. If temperature sensors pass the test, fan testing will follow. The fans in the Ice Qube TMS are numbered as follows:
  - 1: Internal circulation (evaporator) fan 1
  - 2: Internal circulation fan (evaporator) fan 2
  - 3: Condenser fan 1
  - 4: Condenser fan 2
  - 5: Condenser fan 3
  - 6: Hydrogen exhaust fan (currently not available)

**NOTE:** *Depending on the product model, number of operating internal and external fans may vary. Detection only works for the operating fans for each specific model.*



If the fan speed is abnormal, the controller will show two icons  +  and the audible alarm will be activated.

**NOTE:** *If fan cannot pass the test, the detection will stop with alarm. Press any button to exit self-detection.*

The initial test procedure will take about 40 to 60 seconds based on the number of fans in the unit. After the initial test procedure, the TMS will start its normal operation. The internal circulation fan(s) will start to operate. The fan will run continuously so that the controller can monitor the enclosure's internal temperature. The enclosure temperature will be displayed on the face of the controller. When the temperature inside the enclosure is higher than the factory setting 80°F (27°C),  flashes. This indicates that the compressor's automatic off cycle timer is working (The off cycle timer is factory set at 3½ minutes). At the end of 3½ minutes, the compressor and the condenser fan will begin to operate and the snowflake icon will be on continuously. This signifies that the cooling system has begun operation to remove heat and humidity from the enclosure. This procedure may take 20 to 30 minutes before it reaches full capacity.

If the heat load within the enclosure is less than the cooling capacity of the Ice Qube system, the temperature on the digital display will begin to decrease. When the temperature inside the enclosure decreases 7 degrees Fahrenheit below the "Cooling on" setpoint, the compressor and the condenser fan(s) will cycle off. The cool air fan(s) will continue to operate, circulating air within the enclosure. The controller has a factory programmed temperature differential of 7 degrees Fahrenheit. Example: "Cooling on" @ 80°F; "Cooling off" @ 73°F.

The cooling capacity of the Ice Qube TMS can be adjusted through the compressor speed or fan speed. The compressor/external fan speed is at its lowest when the temperature inside the enclosure is equal to the Cool-on setpoint (80°F per factory settings) and reaches its maximum when the temperature inside the enclosure reaches the factory setting of 98°F (37°C). The air conditioner reaches its largest cooling capacity when compressor and fan(s) operate at their highest speed. This function is optional. Refer to "Programming the Controller". When the temperature inside the enclosure is in the 80°F (27°C) -- 98°F (37°C) range, the compressor/fan speed will be in a linear relationship with the enclosure temperature.

The internal circulating fan speed also changes with the enclosure temperature. The fan will be at its full speed when the cooling starts or the heating starts; and the fan speed is adjusted according to the enclosure temperature when between the "cooling on" and "cooling off". In this temperature range, the fan speed increases proportionally to the enclosure temperature. The controller monitors the fan speeds and if anything abnormal is observed regarding the fan speeds, two icons  +  will appear on the controller display.

Ice Qube also offers an optional heating feature. If the enclosure temperature is below the factory heating setpoint of 50°F, the heat status sign  will be shown on the controller display. This indicates the heat relay has been energized and is providing power to the heater. (There is no time delay before heating begins). When the temperature of the enclosure rises 7 degrees Fahrenheit above the setpoint, the controller will de-energize the heat relay and cycle the heater "off".

**NOTE:** *There is a dead band programmed into the controller that prevents heating and cooling from operating simultaneously.  
See the label attached to the air conditioner for maximum wattage requirement of the heater(s).*

## PROGRAMMING THE CONTROLLER:

The digital controller has many function settings that may or may not be required for your application. However, the controller has been set at the factory with typical default settings for immediate system operation. Please review the following default settings.

1. Cooling Start Temperature	80°F (27°C)
2. Heating Start Temperature	50°F (10°C) (optional)
3. High Temperature Alarm	100°F (38°C)
4. Low Temperature Alarm	40°F (4°C)
5. Full Speed Temperature	98°F (37°C)
6. Alarm Light and Sound	“ON” “ON”
7. Default Temperature Unit	Fahrenheit
8. User Pin code Setting	1234
9. Filter Maintenance Alarm	0 day-disabled
10. Communication Address	1

To change the controller settings, please follow the sequence below to enter the pin code 1234 into the program modification:



“+”	1
“-”	2
“Select”	3
“Exit”	4

**Figure 2: Digital Tap Sensitive Controller**

After entering the above sequence, three alternating flashing boxes should be shown on the display face, indicating the code was accepted. If no selection is made within one minute, the system returns to the normal operating mode.

**NOTE:** *If the pin code entering fails at the first time, please wait until the key icon  disappears and then enter the pin code again.*

*Press “Exit” when you need to go back to normal mode from the controller programming mode.*

Press the “**SELECT**” button to continue programming.  + HI icons the 'cooling on' set point is shown on the controller display. The compressor will begin operation at this temperature and will remain operating until the enclosure temperature decreases approximately seven degrees Fahrenheit (four degrees Celsius) below the cooling on set point. Press the “+” or “-” button until the desired set point is displayed. The range for this adjustment is 70° to 126°F, (21° to 52°C).

Press the “**SELECT**” button to continue programming. When  + LO on the screen is shown, it indicates to the 'heating on' setting (optional). The heating system will begin operation at this temperature and remain operating until the enclosure temperature increases approximately seven degrees Fahrenheit (four degrees Celsius) above the 'heating on' set point. Press the “+” or “-” until the desired set point is displayed within a range of -22°F to 68°F (-30°C to +20°C).



**NOTE:** *Review alarm settings if the ‘cool on’ or ‘heat on’ set points have been changed.*

Press “**SELECT**” to continue programming.  + HI icons appearing on the screen indicate the setting for high temperature alarm set point. The alarm will activate at this temperature and will





automatically reset at two degrees Fahrenheit (one degree Celsius) below this temperature. Press the “+” or “-” button to change the alarm set point within a range of 7°F (or 4°C) above the 'cooling on' set point, to 140°F (or 60°C).

Press “**SELECT**” to continue the setting.  + "LO" icons appear on the screen, indicating the setting for low temperature alarm. The alarm will activate at this temperature and will automatically reset at two degrees Fahrenheit (or one degree Celsius) above this temperature. Press the “+” or “-” button to change the alarm setpoint within a range of -31°F (-35°C) to 7° F (4°C) below the 'heating on' set point.

Press “**SELECT**” to continue the setting. When  +  appears on the screen, the display will show the temperature at which the compressor will be running at full speed. Press the “+” or “-” key pads to change the high speed set point within a range from the 'cooling on set point' to 72°F (30°C) above 'cooling on set point'.

Press “**SELECT**” to enter the alarm function setting. The screen shows the current status of the alarm. When “off” is shown on the screen, all the alarm functions will stop. Press “+” or “-” to change the alarm status accordingly. If the “OFF” mode is selected, no alarms will activate and the audible on/off select function is skipped.



Press “**SELECT**” to enter the audible alarm setting. When  or  is lit, “on” or “off” will appear accordingly on the LCD screen to show the status of the audible alarm. Press “+” or “-” to toggle the mode as desired.

Press “**SELECT**” to enter the temperature unit setting. Press “+” or “-” to select the desired temperature unit of Fahrenheit or Celsius.

Press “**SELECT**” to continue. The display shows “PIN”. If you need to set a new pin code, press “+” on the key pad. When “0” shows on the screen, the controller is ready to accept the new pin code. Use the keys “+”, “-”, “**SELECT**” and “**EXIT**” to reset a new 4-digit pin code. (The four keys can be set as pin code in any order). When the first key is pressed on the key pad, the controller display shows -1-, indicating the first digit of the pin code has been entered. numbers -2-, -3-, and -4- are displayed sequentially after pressing the other keys. When the fourth-digit of the pin code is entered, the controller will move on to the next step of the programming. If the fourth pin code is not entered within 60 seconds, the system will log out automatically. The pin code setting fails and the system will continue to use the previous pin code.

**\*\*\* CAUTION\*\*\***

**Always record the selection sequence (PIN code) and store in a secure place.**

Press “**SELECT**” to continue. The  and  icons are displayed and the filter maintenance reminder setting is shown. Press “+” or “-” to change the alarm setting. Its setting range is 0-180 days. Programming 0 days will disable the alarm.

**NOTE: The required number of days to set this alarm will be determined by the ambient air conditions. The filter alarm should be set to “0” to disable the filter alarm for systems that do not have a filter.**

Continue to press “**SELECT**” to enter the communication address setting. The icon  on the LCD screen is displayed and the screen will show the current communication address. Press “+” or “-” to change the address value within range of 1-255. The factory setting of the communication address is 1. This function is not available for certain models.

Programming of the controller is now complete. Press the “**SELECT**” button to review all of the settings. Press the “**EXIT**” button to enter the selected settings and to return to the normal operating mode.





**NOTE: If “EXIT: button is not pressed, any changes to the program will NOT be saved.**

## Recovering the Factory Settings



In order to recover the default factory settings in the controller, press 442213 under the normal operation condition. When the LCD screen shows “---” for 3 seconds, the controller restarts. Then the controller parameters are set back to factory default settings.

## ALARM OPERATION:

### 1. The enclosure temperature is above or below the alarm set point:



The display flashes,  + “HI” +  or  + “LO” +  icons will also flash with the display and the audible alarm sounds (if activated). The enclosure temperature must rise or fall by 2°F (1°C) before the alarm resets.

### 2. The condenser temperature is above the condenser alarm set point:

The display flashes,  + “HI” +  icons will also flash with the display while showing the condenser temperature and the audible alarm sounds (if activated). The LCD shows the enclosure temperature and the above alarm icons alternately. The condenser temperature must fall four degrees Fahrenheit (two degrees Celsius) before the alarm will reset. **The above alarms can be manually reset by entering the PIN CODE code into the system.**

### 3. A fan failure is detected:



The controller in the Ice Qube TMS will test its fan speeds regularly. When a fan malfunctions or its speed is over 35% of the set range, the controller will give a fan malfunction alarm, and the



icons  +  + “fan No.” will appear on the screen. The fan numbers “1” and “2” refer to internal circulating fan; “3”, “4” and “5” refer to external circulating fan; and “6” refers to hydrogen fan. Hydrogen fan option is not available for Qube Series.

### 4. The filter day timer has expired:

The display flashes showing , and the audible alarm sounds (if activated). The filter alarm can be cleared by pressing “EXIT”.

### 5. A sensor malfunction has been detected:

 +  +  + “---” indicates the evaporator sensor malfunction

 +  +  + “---” indicates the condenser sensor malfunction

**NOTE:** An alternating  +  +  +  display may indicate the sensor connector has become disconnected from the rear of the controller.

## MAINTENANCE:

The Ice Qube air conditioning system is designed to provide many years of trouble-free operation with minimal amount of maintenance. Primary maintenance consists of checking the condition of the ambient air filter (optional for Blade Series) and the condensate management system.

1. **Ambient Air Filter:** It is recommended that the ambient air filter be inspected and cleaned regularly, at least every 90 days, or more frequently depending upon ambient conditions. To check the condition of the air filter, it is recommended to first remove electrical power from the Ice Qube system. Next, locate the filter cover and filter, (location will vary by model). Slide the filter from the filter rack through the end slot, and clean by soaking in warm soapy water. Rinse with clean water. Use a shop-vac to remove excess water from the filter before returning it to the system. Replace the filter if it is showing signs of deterioration.

**NOTE:** *If rain or wash down hoods have been installed, a filter would not have been supplied, therefore no filter maintenance is required. However systems equipped with rain or wash down hoods will require regular condensing section maintenance by qualified personnel. For systems equipped with filters, it is recommended to have a spare clean filter in stock in order to prevent prolonged cooling system downtime. The dirty filter may be cleaned at a more convenient time.*

2. **Condensate Drain Nipple:** The condensate drain nipple should be checked periodically for scale, sludge and debris that may cause the system to fail. On open type enclosures and in areas where the enclosure door is opened frequently within dirty or industrial environments, maintenance should be performed on a regular basis. On sealed enclosures, clean environments, or where the door is not opened frequently, maintenance may be performed less frequently. The type of environment will determine the frequency of required maintenance.
3. **Cooling system cabinet:** The cooling system cabinet may also need to be cleaned occasionally. To clean the system cabinet, simply wipe it with a damp, lint free cloth. A mild soap solution may be used if necessary.

## TROUBLESHOOTING:

Contact Ice Qube if the air conditioning system should fail to operate satisfactorily during the first year of operation. **DO NOT** remove the cover without first notifying the factory. **Removal of the cover will immediately void the warranty.**

If an operating problem should occur, please review the items outlined in the following "Trouble Shooting Check List". If the problem persists, obtain model and serial number before contacting Ice Qube for technical assistance.



## TROUBLESHOOTING CHECK LIST

<b>Model No:</b>		<b>S/N Number:</b>		
Voltage Rating:	Amps:	Phase:	Hz:	
Is proper electrical power available at the supply?		YES <input type="checkbox"/>	NO <input type="checkbox"/>	
Is the power cord connected to the electrical supply?		YES <input type="checkbox"/>	NO <input type="checkbox"/>	
Is the controller set point temperature above or below the enclosure temperature?		YES <input type="checkbox"/>	NO <input type="checkbox"/>	
Is the evaporator (cold air stream) blower operating?		YES <input type="checkbox"/>	NO <input type="checkbox"/>	
Is the compressor and condenser (warm air stream) blower operating?		YES <input type="checkbox"/>	NO <input type="checkbox"/>	
Is the enclosure door closed tightly?		YES <input type="checkbox"/>	NO <input type="checkbox"/>	
Are all of the gaskets in place?		YES <input type="checkbox"/>	NO <input type="checkbox"/>	
Has the condenser (warm air stream) filter been cleaned or changed recently?		YES <input type="checkbox"/>	NO <input type="checkbox"/>	
Is the system mounted level on the enclosure?		YES <input type="checkbox"/>	NO <input type="checkbox"/>	
Is there adequate space within the enclosure for air flow?		YES <input type="checkbox"/>	NO <input type="checkbox"/>	
Is there adequate space around the enclosure for air flow?		YES <input type="checkbox"/>	NO <input type="checkbox"/>	
Have you recently added electronic equipment to the enclosure?		YES <input type="checkbox"/>	NO <input type="checkbox"/>	

Still experiencing problems? Please Call Ice Qube at 1-724-837-7600 or 1-888-867-8234  
**Make sure you have your model and serial number ready before you call.**

# Qube Series Schematic Wiring Diagram

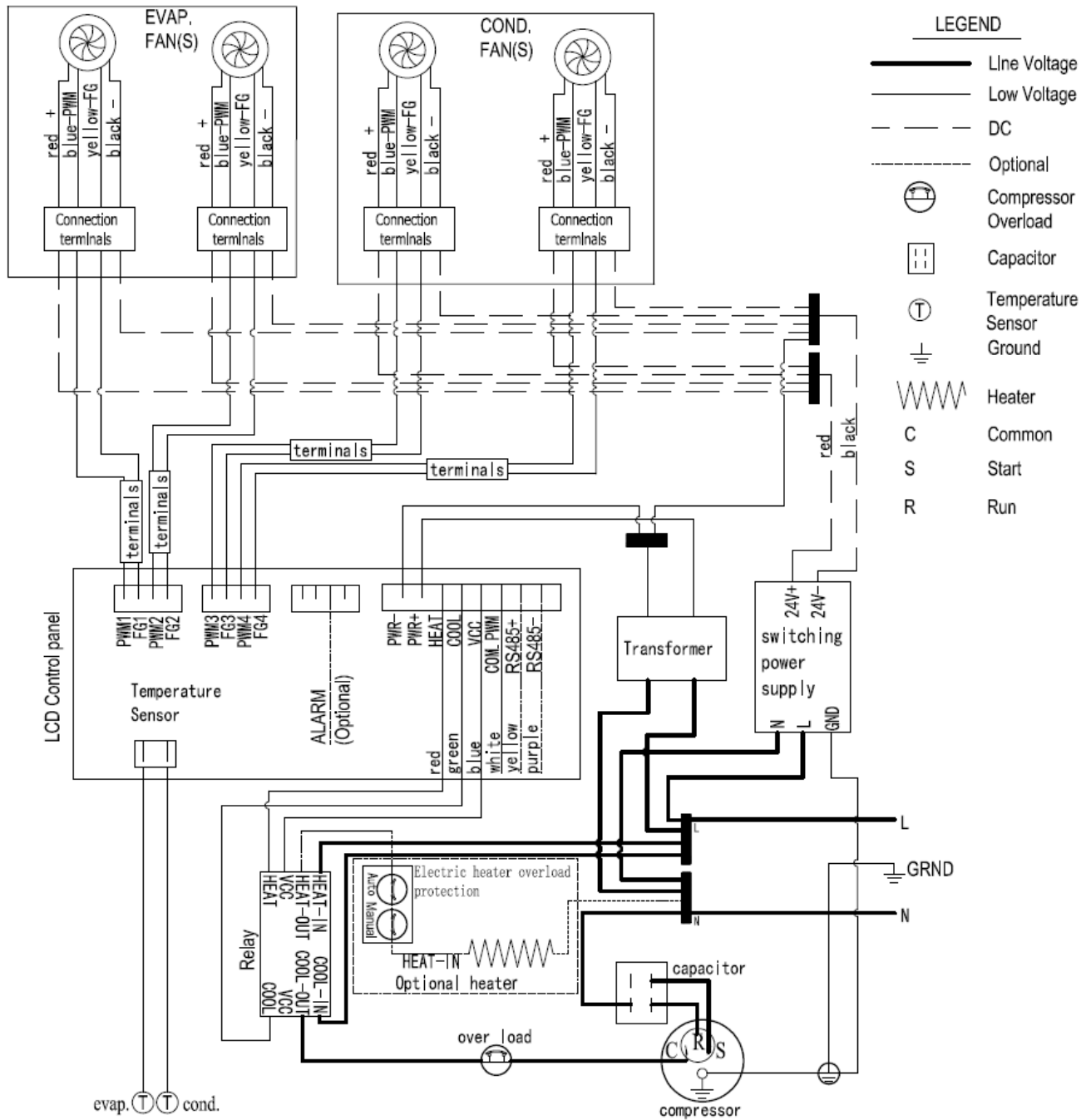

NOTE: Number of evaporator and condenser fans may vary depending on the model.

# Blade Series Schematic Wiring Diagram

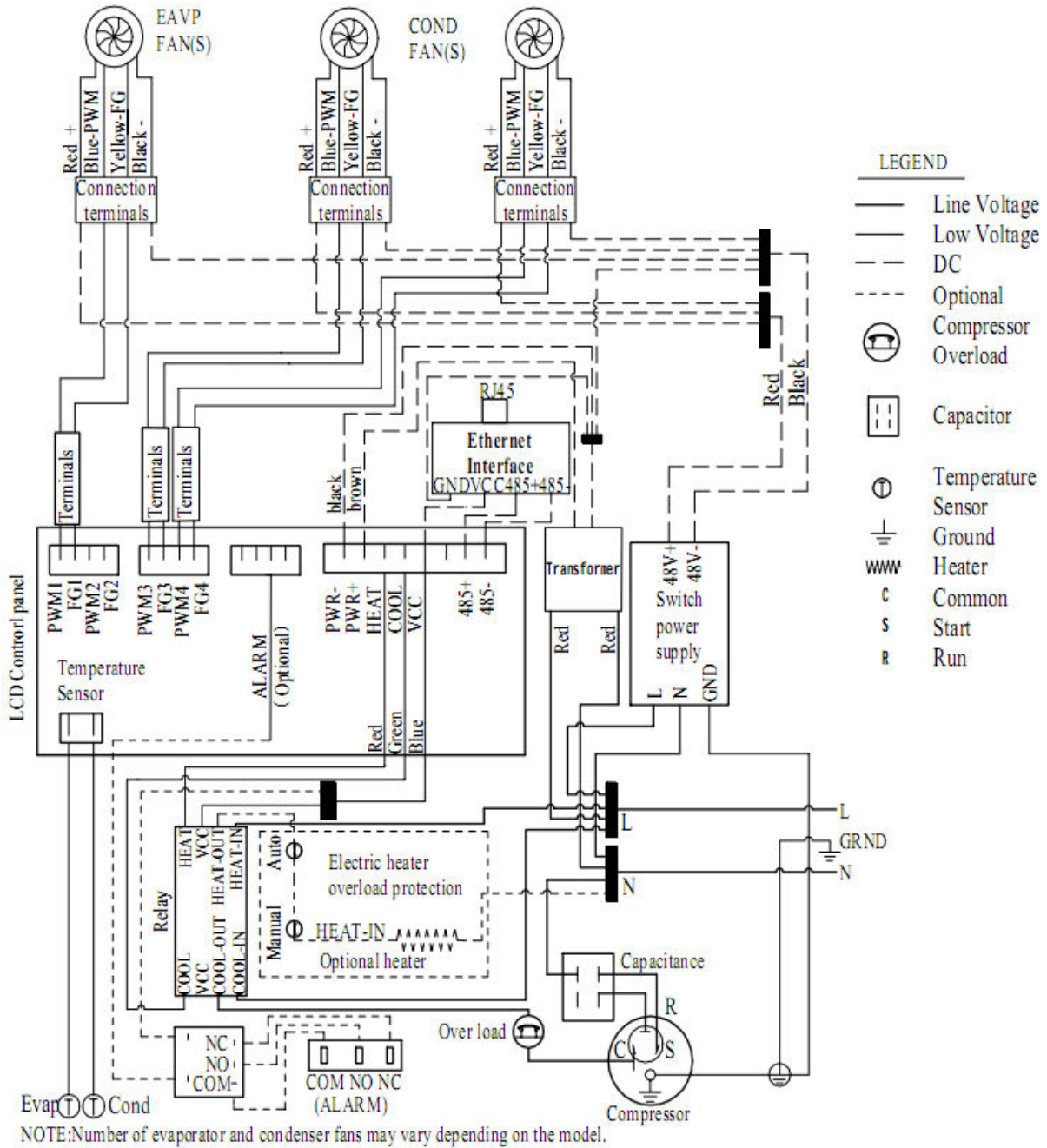

### Standard Warranty Policy

Ice Qube, Inc. ("Ice Qube") warrants that the products manufactured by Ice Qube (the "Products") are free of defects in material and workmanship which impair the operation of the Products, under normal and proper use and service, for a period of one (1) year from the date of shipment FCA from Ice Qube's facility located in Greensburg, Pennsylvania (the "Standard Warranty").

In order for this Standard Warranty to apply, the Product(s) must be installed and operated according to and consistent with the following conditions:

- Voltage variation no greater than +/- 10% from the rated voltage on the label of the Product;
- Frequency variation no greater than +/- 3 HZ from rated frequency on the label of the Product;
- Ambient temperature must not exceed maximum operating temperature on the label of the Product;
- Maximum cooling capacity not to exceed rating (BTU/HR) as rated on the label of the Product; and
- The Product must be installed, maintained and operated consistent with the terms and conditions set forth in the operation manual.

#### **THIS STANDARD WARRANTY DOES NOT COVER THE FOLLOWING:**

- Ice Qube assumes no liability beyond the repair or replacement of its own Products. In no event shall Ice Qube be liable for any incidental, special, indirect, consequential or similar damages incurred by any purchaser, owner, possessor, assignee or successor in interest or any other third party having any interest in any Product as the result of any breach of this Standard Warranty, including but not limited to loss of profit or revenues, damages for loss of use of the Products, damage to property, both real and personal, claims of third parties, including personal injury or death on account of use of the Products or failure of Ice Qube to warn against or instruct on or adequately warn against or instruct on, the dangers of the Products or the safe and proper use of the Products, whether or not customer has been advised of the potential for such damages.
- Ice Qube's total liability for customer's claims from any cause whatsoever, whether arising under contract, warranty, tort (including negligence), strict liability, products liability or any other theory of liability, will be limited to the lesser of customer's actual damages or the price paid by customer to Ice Qube for the Products (not including applicable taxes, duties and freight charges) that are the subject of customer's claim.

THE WARRANTY SET FORTH HEREIN IS STRICTLY LIMITED TO ITS TERMS AND IS IN LIEU OF ALL OTHER WARRANTIES, GUARANTEES, EXPRESS OR IMPLIED, ARISING BY OPERATION OF LAW, COURSE OF DEALING, CUSTOM, USAGE OF TRADE OR OTHERWISE, SPECIFICALLY EXCLUDING ANY IMPLIED WARRANTIES OF MERCHANTABILITY OR FITNESS FOR A PARTICULAR PURPOSE OR USE.

1. The warranty and remedies for breach of warranty provided for in this Standard Warranty extend only to the original installation and do not cover, and Ice Qube will neither assume responsibility, nor be liable, for the following:
  - misapplication of its Products or the erroneous selection of an inappropriate Product by a non-authorized Ice Qube representative;
  - use of the Product for other than its designed purpose or operating conditions;
  - operation or storage in harsh, oily, corrosive or other abnormal environments without the proper filtration, sealing, protective coatings and/or weather protection;
  - damage to the hermetic system resulting from continuous operation with dirty or clogged air filters or improper or negligent maintenance;
  - use of refrigerant other than designated on the label of the Product;
  - customer modification or abuse;
  - shipping damage or other accidental damage (It is Ice Qube's standard policy that freight claims are the responsibility of the customer if the Product is not refused at delivery);
  - repair, damage or service of the Product caused by anyone except personnel authorized by Ice Qube;
  - cracked or broken hermetic tubing, brazed joints or other internal damage caused by shipping or mishandling;
  - damage caused by shipping units attached to an enclosure;
  - any and all damage, breakage, malfunction or other like conditions or defects resulting from noncompliance with the standard operation, care, installation, maintenance and use of the Product as set forth in the operation manual for such Product;
  - any cause beyond the control of Ice Qube, including without limitation conditions caused by movement, settlement or structural defects of the environment in which the Products are installed;
  - fire, wind, hail, flood, lightning or other acts of God;
  - any damage to the finish of the Products after they leave Ice Qube's facility;
  - any discoloration or spotty appearance of the Products;
  - return freight and shipping charges, along with applicable duties and other like fees and charges, for the return of the Product to Ice Qube (such amounts are the sole responsibility of the customer);
  - failure to process or inaccurate processing of time-sensitive information and/or mechanisms; or
  - exposure to harmful chemicals, pollutants or other foreign matter or energy.
2. All returns must have a RMA number and must be marked with the RMA number on the bill of lading and on the packaging.

3. Upon resale, customer agrees to extend to its customers no greater warranties, and limit its liability and remedies to the same extent, as those set forth herein.
4. All Product literature is for illustrative purposes only and does not contain a warranty of any kind.
5. Ice Qube's advice relating to the technical usage of the Products or the intellectual property rights of others, whether provided orally or in writing or through the provision of test results, is given in accordance with Ice Qube's best knowledge at that time, but shall at all times be deemed to be non-binding. Such advice does not relieve customer from the obligation, and customer accepts full responsibility, to confirm for itself the suitability of the Products for their intended purpose(s).

#### Remedies

Customer's sole and exclusive remedy, and Ice Qube's only obligation for breach of warranty hereunder shall be, at Ice Qube's option, in its sole discretion, to (i) repair or replace the defective Product which fails within the one (1) year warranty period, free of charge, provided that customer promptly notifies Ice Qube of such failure and, after receipt of prior written authorization and return authorization number from Ice Qube, which will be given or withheld at Ice Qube's sole discretion, returns such Product to Ice Qube, Inc., 141 Wilson Avenue, Greensburg, PA 15601, or such other place as requested by Ice Qube, freight prepaid, and thereupon Ice Qube finds such to be defective or (ii) issue a credit equal to the price of the defective Product which fails within the one (1) year warranty period. Customer must pay all related costs of repair or replacement, including removal, installation or reinstallation costs. Ice Qube's personnel must be granted access to inspect the Products claimed to be defective at the site of their installation or use. Products repaired or replaced and designs corrected under this Standard Warranty are warranted only for the remainder of the original warranty period.

#### In-Field Service for Continental United States<sup>1</sup>

All standard duty air conditioners manufactured by Ice Qube are eligible for in-field service, where available, at no charge to customer, for a period of one (1) year from the date of shipment FCA from Ice Qube's facility in Greensburg, Pennsylvania. However, such in-field service is only available at the sole discretion of Ice Qube. In-field service may not be available in all service areas and the provision of in-field service is subject to change at any time by Ice Qube without notice. The location of the Product otherwise eligible for in-field service must be within One Hundred (100) miles of the service center selected by Ice Qube in its sole discretion. In-field service is only available in the Continental United States.

All in-field services must be initiated by Ice Qube. Customers must call Ice Qube support service at (724) 837-7600 and work with the Ice Qube support personnel so that Ice Qube can determine the necessity of in-field service for such Product in its sole discretion.

Ice Qube will not assume any liability for any in-field service not initiated by Ice Qube. In no event shall Ice Qube be liable for any incidental, special, indirect, consequential or similar damages incurred by any purchaser, owner, possessor, assignee or successor in interest or any third party having any interest in any Product as the result of the provision of any in-field services to such Product, including but not limited to loss of profit or revenues, damages for loss of use of the Products, damage to property, both real and personal, claims of third parties, including personal injury or death on account of use of the Products or failure of Ice Qube to warn against or instruct on or adequately warn against or instruct on, the dangers of the Products or the safe and proper use of the Products, whether or not customer has been advised of the potential for such damages.

Ice Qube's total liability in connection with in-field services from any cause whatsoever, whether arising under contract, warranty, tort (including negligence), strict liability, products liability or any other theory of liability, will be limited to the lesser of customer's actual damages or the price paid to Ice Qube for the Products (not including applicable taxes, duties and freight charges) for which in-field services are sought.

ALL HAZARDOUS DUTY AIR CONDITIONERS ARE EXCLUDED FROM IN-FIELD SERVICE DUE TO CERTIFICATION. TO THE EXTENT APPLICABLE, SPECIFICALLY EXCLUDED FROM IN-FIELD SERVICES INITIATED BY ICE QUBE ARE ANY AND ALL OTHER WARRANTIES, GUARANTEES, EXPRESS OR IMPLIED, ARISING BY OPERATION OF LAW, COURSE OF DEALING, CUSTOM, USAGE OF TRADE OR OTHERWISE, SPECIFICALLY EXCLUDING ANY IMPLIED WARRANTIES OF MERCHANTABILITY OR FITNESS FOR A PARTICULAR PURPOSE OR USE.

ALL QUBE AND BLADE SERIES UNITS ARE EXCLUDED FROM IN-FIELD SERVICE. THESE UNITS WILL EITHER BE RETURNED TO THE FACTORY FOR REPAIR OR MAY BE ELIGIBLE FOR A REPLACEMENT UNIT. THIS WILL BE AT THE SOLE DISCRETION OF ICE QUBE, INC.

#### Extended Warranty Options

Ice Qube offers extended warranty options on a per Product basis. Please contact Ice Qube at (724) 837-7600 for further information. All extended warranties must comply with all applicable provisions of the Standard Warranty listed above.

All Products with extended warranties must be registered with Ice Qube and must be installed and maintained according to the operation manual and according to the terms and conditions set forth in the Extended Warranty for such Product.

---

<sup>1</sup> In-field service outside the Continental United States is only offered on a case by case basis in Ice Qube's sole discretion. Customers outside the Continental United States must call Ice Qube support service at (724) 837-7600 and consult with the Ice Qube support personnel so that Ice Qube can determine the availability of in-field service at such location.