



Cooling Solutions



## Evolution Series Air Conditioners

Class I Zone 2 AEx / Ex and  
Zone 2 ATEX / IECEx Hazardous Locations\*

# OPERATION AND INSTALLATION MANUAL

\*\*\* IMPORTANT \*\*\*

PLEASE READ this manual and follow the instructions for safe and satisfactory installation and operation of this system. Keep this manual for future reference. Some information may not apply to all systems.

RELATED DRAWING; DO NOT CHANGE WITHOUT AUTHORIZED PERSON APPROVAL

\* FOR CLASS I ZONE 2 AEx / Ex AND ZONE 2 ATEX / IECEx UNITS, ALL COMPONENTS ARE NON-IGNITION SOURCE COMPONENTS AND DO NOT REQUIRE PURGE PROTECTION FROM ANY SOURCE

<b>Introduction</b> .....	3
<b>Basic Unit Operation</b> .....	3
<b>Preservation Instructions</b> .....	4
<b>Pre-Installation Test</b> .....	5
<b>Preparing the Enclosure</b> .....	6
<b>Mechanical Installation Instruction</b> .....	6
<b>Electrical Installation Instruction</b> .....	8
<b>Alarm Installation Instruction</b> .....	10
<b>Operating Your System</b> .....	10
<b>Programming the Standard Controller</b> .....	11
<b>Alarm Operation</b> .....	13
<b>Maintenance</b> .....	14
<b>Trouble Shooting</b> .....	14
<b>Schematic Wiring Diagrams</b> .....	16
<b>120V/220V/230V/240V</b> .....	16
<b>400V/440V/460V/480V</b> .....	17
<b>Standard Warranty Policy</b> .....	18
<b>Notes:</b> .....	20

## Introduction

Ice Qube computer and electronics enclosure cooling systems have been designed to provide a safe environment for your equipment. Our cooling systems provide this environment by cooling and dehumidifying the enclosure that houses your equipment while providing an efficient, modern, and aesthetically pleasing package requiring minimal maintenance. Our closed-loop circulation design also protects your equipment from air-borne dust and contaminants which may hinder your equipment operations and cause unnecessary downtime. Ice Qube offers various models of cooling systems ranging in cooling capacity from 1,000 to 27,000 BTU per hour to provide air conditioning systems for many of your environmental needs, including hazardous locations. Ice Qube cooling systems are available in top and side mount packages.

## Basic Unit Operation

The Ice Qube Thermal Management System (TMS) is a combination of several systems that function simultaneously to maintain environmentally friendly conditions for your equipment within the enclosure. The three main thermal related systems that we employ are the closed-loop cold air supply stream, the heat rejection air stream, and the vapor-compression refrigeration system.

The closed-loop cold air supply stream circulates cold air from the Ice Qube TMS to your electronics enclosure. This air returns to the Ice Qube TMS bringing with it unwanted heat and humidity from inside your enclosure. Heat and humidity is then removed by a heat exchanger which is part of the vapor-compression refrigeration system.

At the heart of the vapor-compression refrigeration system is a quiet, energy efficient rotary compressor, which circulates environmentally friendly NON-CFC refrigerant to transfer heat from the heat exchanger (evaporator) located within the closed-loop air stream to a heat exchanger (condenser) located in the heat rejection air stream. In the heat rejection air stream, air is circulated from the ambient air surrounding the enclosure, through a filter, and across the warm heat exchanger. Here, heat from the enclosure is transferred from the warm heat exchanger to the heat rejection air stream and dissipated to the ambient air.

**Condenser Heat  
Rejection Air Stream**

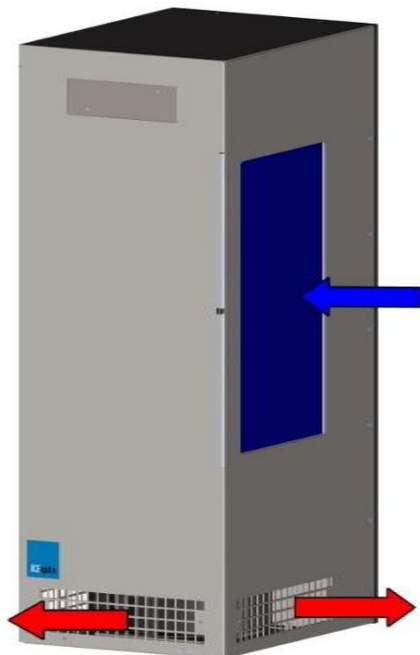

**Evaporator Cold  
Air Supply Stream**

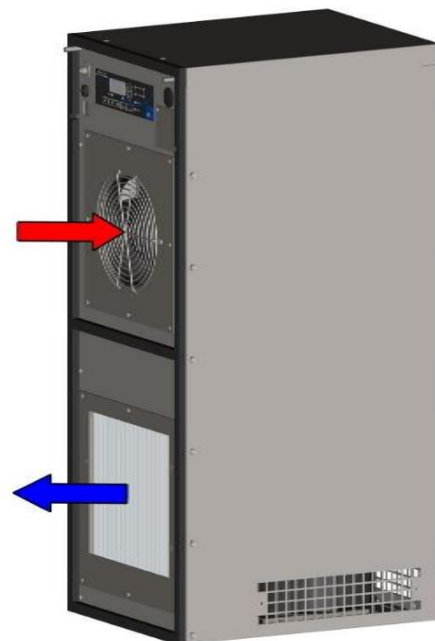

## Preservation Instructions

### Unpacking Inspection

**Caution:** *It is recommended using gloves and protective eyewear when unpacking*

Verify product is as identified on the packing list. Air conditioner should arrive banded to pallet in the proper upright position. See arrows on packaging for verification. Any evidence of damage should be noted on the freight bill. The freight carriers claim procedure should be followed. **Ice Qube cannot accept responsibility for damages that occur during shipping.** If the shipping container was damaged or marred in any way, check for scratches, dents, loose hardware, presence of oil or any other irregularities with the Ice Qube TMS.

### Package Contents

Included in the shipment with the air conditioner will be:

1. Operation manual
2. Mounting hardware
3. Condenser air diverter plate
4. Standard master warranty
5. Ethernet controller manual (Optional)
6. Cutout Template (Optional)

### Handling

Ice Qube recommends that the unit remains in the proper upright position, as indicated on the shipping container. The unit must remain upright for a minimum of 24 hours before initial operation to ensure oil has returned to the compressor. Operation before the 24-hour time may cause compressor damage and shorten the life of the system. *Operation before this 24-hour period will void all warranties.*

### Storage

The storage space temperature should be in the range of -40 to 85°C (-40 to 185°F) in a non-condensing environment.

### Ambient Temperature Range

-40 to 60°C (-40 to 140°F)

**CONDITIONS OF ACCEPTABILITY:** When installed in the end use equipment, the following considerations are to be examined:

1. The maximum operating temperature of the devices while subjected to the temperature test at a 60°C ambient air temperature is in accordance with the temperature class can be found on the appropriate spec drawings which are available at <http://www.iceqube.com>
2. The subject devices must be used within their Recognized “Ratings” and conditions of acceptability as referenced in the User’s Manual.
3. Consideration is to be given to the Conditions of Acceptability specified in the individual recognitions when these components are employed in the end-use equipment

## Pre-Installation Test

Before installing the Ice Qube system on your enclosure, Ice Qube recommends that the unit operates for 20-30 minutes to ensure it is functioning properly. Although the Ice Qube TMS has been tested at the factory, internal damage may have occurred during shipping which may have not been apparent during the unpacking inspection.

1. Place the system on a solid base such as a workbench or table. Ensure that the weight of the unit will be supported. Be sure to allow adequate space for airflow. The cold air supply stream and the heat rejection air stream must not be restricted.
2. Check that the warm air system filter is in place.
3. Check the data tag for proper electrical requirements. The data tag lists the design voltage and amperage requirements of the system. Verify that the electrical supply where the system will be connected has the proper capacity. After noting the above, connect power from a properly grounded electrical connection. The use of an extension cord is not recommended. *See*

## **Electrical Installation Instruction** for wiring details.

***Note: If any unusual noise or vibration is present during the testing procedure, immediately disconnect the power and inspect the exterior of the unit for the cause of noise or vibration. If necessary, Contact Ice Qube immediately to determine cause of the noise/vibration.***

4. As soon as power is supplied to the system, the cool air evaporator blower will begin to operate. The compressor and warm air condenser blower will not operate if the room air temperature is below 80°F (27°C). This is due to the fact that the programmable controller has a factory set-point of 80°F (27°C). The digital display on the face of the controller will be displaying room temperature. If the display is indicating 80°F (27°C) or warmer, the “Cool” status LED will flash for 3 ½ minutes before the compressor and the warm air condenser blower will operate. If testing in low ambient conditions, the condenser fan may come on for a few seconds and shut off. This is due to a low pressure switch that controls the condenser fan operation. Once system pressure rises the condenser fan will begin to operate.

***Note: If the display is indicating a temperature less than 80°F (27°C), adjust the set-point to a temperature lower than the room temperature in order for the compressor and warm air condenser blower to operate. Refer to Programming the Standard Controller in order to change the factory set points.***

5. With the compressor and both blowers functioning, allow the unit to operate for 20 to 30 minutes. This will provide sufficient time for the vapor compression system to achieve equilibrium. Measure the cool air outlet temperature with an accurate thermometer. For room temperatures above 70°F (22°C), the cool air outlet temperature should be at least 10°F (6°C) colder than the air inlet temperature. Inlet air temperature will be displayed on the programmable controller. In areas of high humidity or ambient temperature below 70°F (22°C), the temperature difference may be less than 10°F (6°C).
6. Models that require maintaining a positive purge pressure or closed loop will require the condensate trap to be filled. Carefully and slowly pour 8.0 ounces (250mL) of clean water into the drain pan located on the rear of the unit. Look for label marking. Some water may drain from the condensate overflow nipple underneath of the unit during this procedure.
7. After completing the above check point, the Ice Qube TMS is ready to be mounted to your enclosure.

## **Preparing the Enclosure**

Please read entire section before beginning installation. The Ice Qube TMS has been designed to be light in weight for easy installation. Side mount units have been designed with a simple two stud alignment feature to make initial fastening to the enclosure quick and easy. A few modifications must be made to your enclosure to provide proper air flow, maintain enclosure integrity, and assure secure installation. Required modifications will vary with Ice Qube TMS model.

1. Ensure the mounting surface and enclosure will support the weight of the Ice Qube TMS and will not become unstable causing bodily harm or equipment damage. For units mounted on enclosure doors, confirm hinges will support the weight of the Ice Qube TMS. Refer to individual specification drawings for model weights
2. Using the specification drawing, determine the ideal location to install the Ice Qube TMS on your enclosure.

3. Upon deciding the installation location of the Ice Qube TMS on your enclosure, use the cutout drawing to determine the necessary modifications to your enclosure surface needed to accommodate mounting of the Ice Qube TMS. An Electronic copy is available at <http://www.icecube.com/downloads/specification-drawings/>
4. Ensure the Ice Qube TMS will be mounted level.
5. Ensure the inlet and outlet of the cold air stream will not be restricted by equipment or shelving within your enclosure.
6. Check that the air flow of the warm air stream will not be affected or restricted.
7. Confirm the gasket is properly installed to the Ice Qube TMS. This gasket is required to create a seal against your enclosure and will maintain enclosure integrity.

### **Mechanical Installation Instruction**

***Caution: Protective safety clothing such as helmet, gloves, and steel toe shoes are recommended.***

1. Position the Ice Qube TMS so that the two mounting studs are in alignment with the top two 3/8" (9.5mm) or 1/2" (12.7mm) depending on model, holes in your enclosure surface.
2. Slide the Ice Qube TMS mounting studs through the 3/8" (9.5mm) or 1/2" (12.7mm) depending on model, holes in your enclosure and check to see that all openings are aligned.
3. After checking that all opening and bolt holes are in alignment, assemble and tighten the (2) 1/4"-20 or 3/8"-16 nuts and (4, 6 or 8 depending on model) 1/4"-20 x 1" bolts supplied with you Ice Qube TMS by hand. Check to ensure gasket will properly seal the Ice Qube TMS to your enclosure.
4. Using a wrench, tighten the nuts and bolts until the gasket between the air conditioner and the enclosure is compressed to half the thickness of the gasket. Check the entire perimeter of the gasket/enclosure interface for compression and seal.
5. The **OPTIONAL** purge connector is provided as a means to purge harmful gases out of the evaporator compartment. This 1/4" (6.35MM) O.D. push-to-connect fitting is for convenience only and is **NOT REQUIRED** as a method of protection. All components are non-ignition source components and **DO NOT** require purge protection from any source. (See *Figure 2: Push-to-Connect Fitting*)
6. The air diverter plate is shipped attached to the condenser outlet below the filter. The air diverter plate can remain as installed, moved to either of the other 2 sides, or removed entirely for omnidirectional air flow.
7. Mechanical installation is now complete. Continue with the electrical installation of the Ice Qube TMS.
8. Connect external M6x12mm cabinet ground stud to secure earth ground (nut and wire terminal are provided).

Ambient Side

Enclosure Side

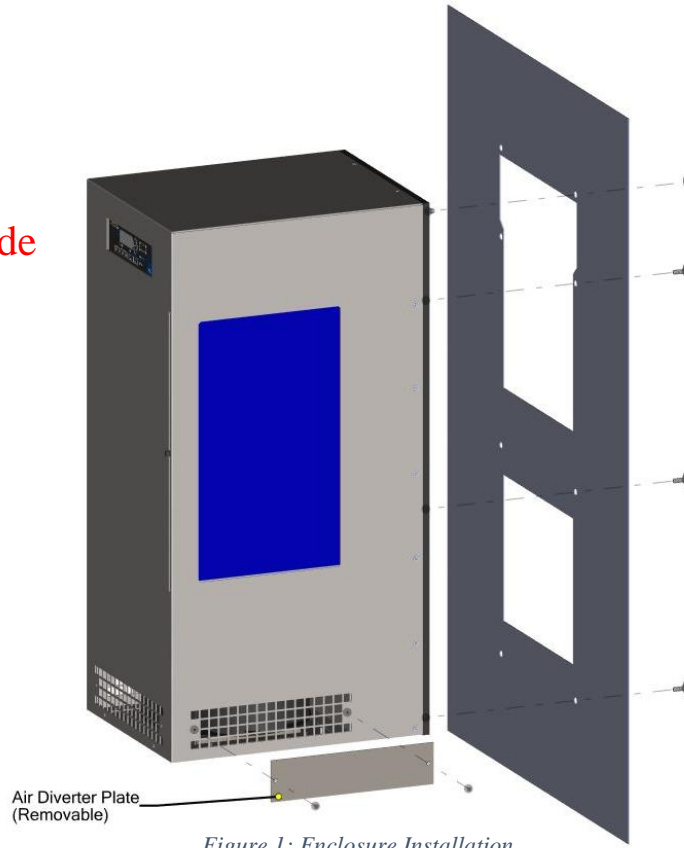

Figure 1: Enclosure Installation

Push-to-Connect Fitting (Optional)

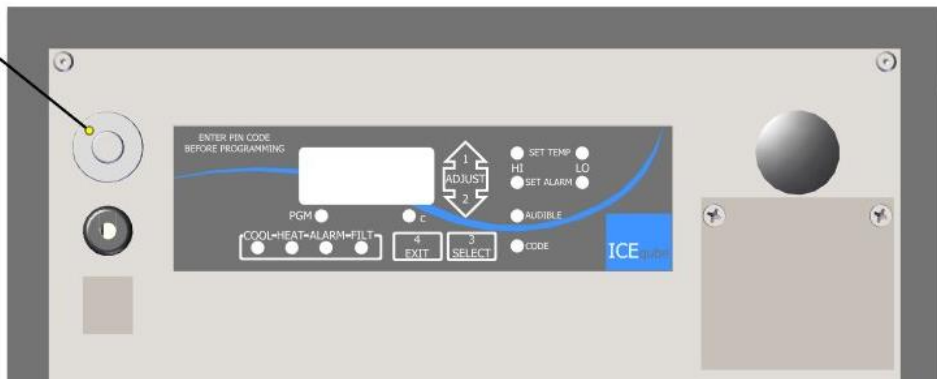

Figure 2: Push-to-Connect Fitting



## Electrical Installation Instruction

Please read the entire section before beginning the electrical installation of the Ice Qube TMS. Ice Qube air conditioners have been designed for easy electrical power connection at one specific location on the enclosure side of the Ice Qube TMS. Each Ice Qube TMS been designed to operate at a range of voltages and frequencies. See unit label(s) for correct voltage and frequency for your model(s).

### ••WARNING: ELECTRICAL SHOCK AND EXPLOSION HAZARD••

**Electrical connections should only be completed by a qualified technician. Compliance with all safety and electrical codes are required. Contact local authority having jurisdiction as required. Do not connect while the circuit is energized. Turn off circuit breaker and install lock out. The area is to be free of ignitable concentration of gases.**

### ••AVERTISSEMENT : RISQUE DE CHOC ÉLECTRIQUE ET D'EXPLOSION••

**Les branchements électriques ne doivent être effectués que par un technicien qualifié. Le respect de tous les codes de sécurité et électriques est requis. Communiquez avec l'autorité locale compétente au besoin. Ne pas connecter lorsque le circuit est sous tension. Coupez le disjoncteur et installez le verrouillage. La zone doit être exempte de concentrations de gaz inflammables.**

#### Pre-Installation Checks

1. Check the air conditioner model label or specification for power requirements.
2. Check the designated air conditioner power supply for adequate and proper electrical power requirements.
3. Check that wire routing to the terminal box will not interfere with or become damaged by other components.

#### Electrical Installation

1. Check that the air conditioner designated power supply is de-energized and locked out.
2. Locate terminal box on enclosure side of air conditioner.
3. Remove the (2) terminal box cover screws and remove the cover. (See Figure 3: Terminal Cover). The terminal block will be used for power. (See Figure 4: Terminal Block)
4. Remove Dome Plug and route power cable through the 0.875" (22.23mm) hole. (See Figure 3: Terminal Box Cover) Use an approved strain relief to secure wires.
5. Connect from left to right, Line 1, Line 2 and Ground. (See Figure 5: Power Terminal Block)
6. Once power is securely connected, install terminal box cover, using the (2) screws.

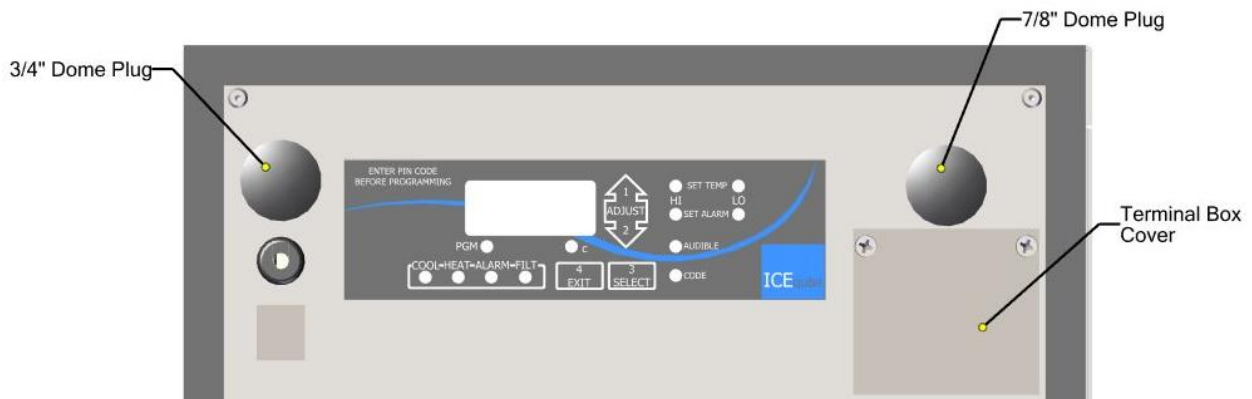

Figure 3: Terminal Cover

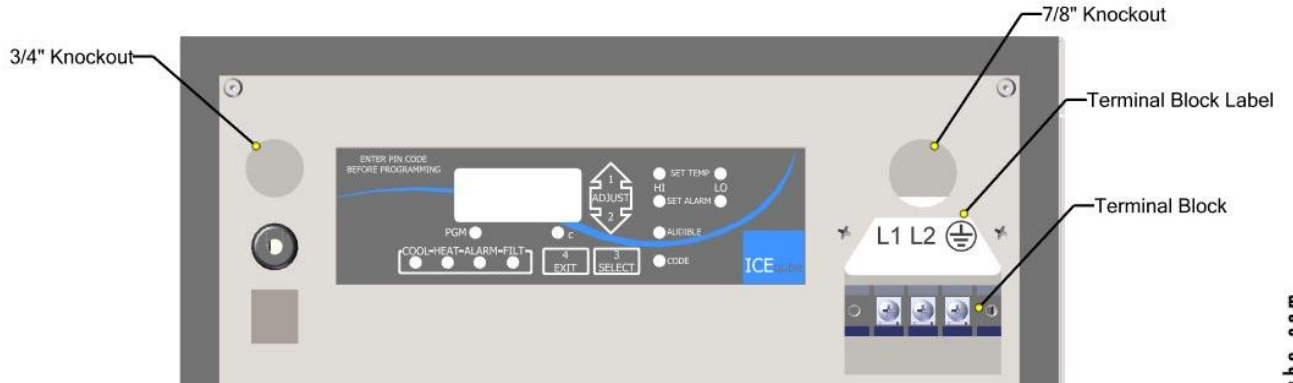

Figure 4: Terminal Block

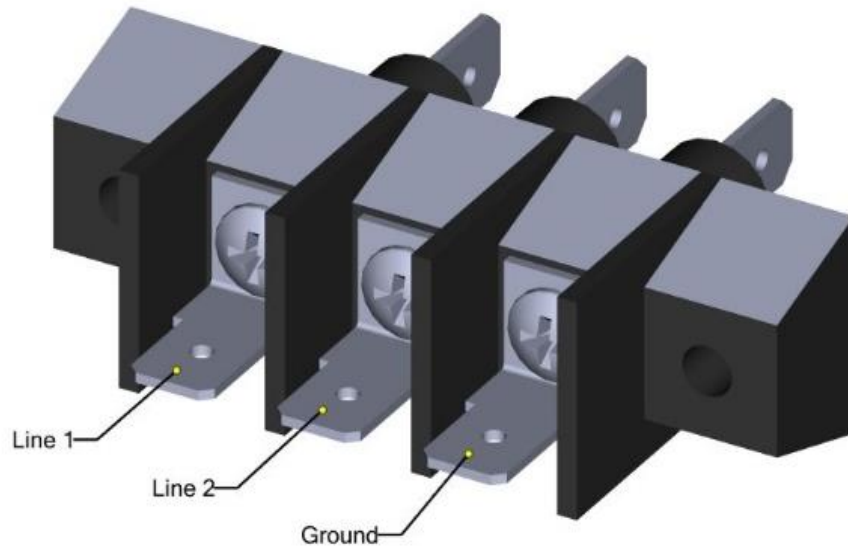

Figure 5: Power Terminal Block

## Alarm Installation Instruction

Ice Qube offers an optional alarm output that is provided through an alarm relay. This option is a dry contact (no voltage.) The alarm will be configured both normally open and normally closed. (X03) When the alarm output is supplied, a 120”(3048mm) cable with 3 flying leads, Common (Black), Normally Open (White), and Normally Closed (Red) will be installed. (See Figure 6: Alarm Output)

### Pre-Installation Checks

1. Ensure that the power connected to the alarm wires is in an NEC approved Class 2 circuit.
2. Check that alarm wire routing from the unit will not interfere with or become damaged by other components.

### Alarm Installation

1. Check that both the air conditioner designated power supply and the alarm power supply is de-energized and locked out.
2. Route alarm wire cable to the desired location. The alarm wires are 18AWG stranded copper conductors.

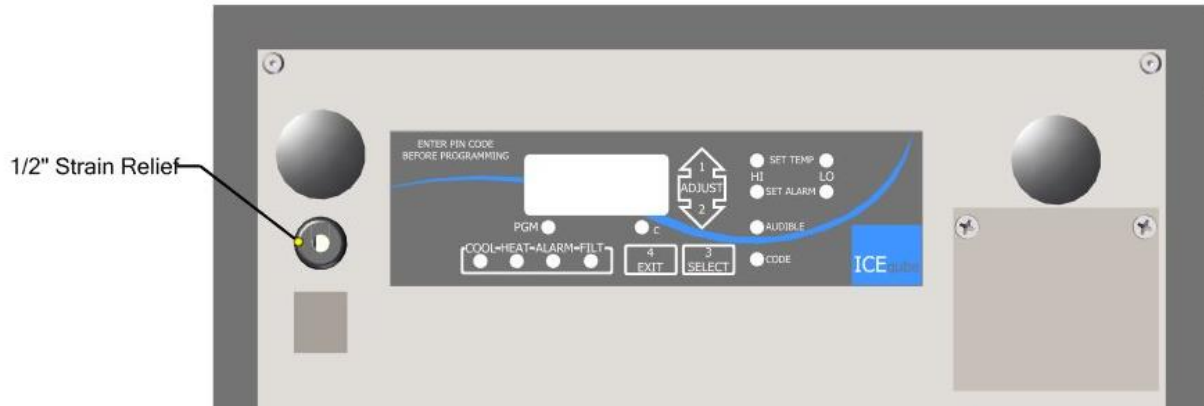

Figure 6: Alarm Output

## Operating Your System

Once the Ice Qube TMS has been installed onto the enclosure and the power cable has been attached to a properly grounded electrical connection with adequate voltage and current supply, the unit is ready for operation. As soon as electrical power is supplied to the Ice Qube TMS, the cool air stream blower will start to operate. The blower will run continuously so that the controller can monitor the enclosure’s internal temperature. The enclosure temperature will be displayed on the face of the controller.

If the enclosure temperature is greater than the factory cooling set-point of 80°F (27°C), the “Cool” status LED will flash. This indicates that the compressor’s automatic off cycle timer is working. The off cycle timer is factory set at 3 ½ minutes. At the end of the 3 ½ minutes, the compressor and the condenser air blower will begin to operate and the cool LED will be steady. This signifies that the cooling system has begun operation to remove heat and humidity from the enclosure. The model may take 20 to 30 minutes before it achieves full capacity.

If the heat load within the enclosure is less than the cooling capacity of the Ice Qube TMS, the temperature on the digital display will begin to decrease. When the temperature inside the enclosure decreases 7°F (4°C) below the “Cooling On” set-point, the compressor and condenser blower will cycle off. The cool air blower will continue to operate, circulating air within the enclosure. The controller has a factory programmed temperature differential of 7°F (4°C). Example: “Cooling On” @ 80°F (27°C); “Cooling Off” @ 73°F (23°C).

## Programming the Standard Controller

The digital controller has many features that may or may not be required for all applications. The controller has been programmed at the factory with typical default settings for immediate system operation.

Please review the following default settings:

- |                                     |                       |
|-------------------------------------|-----------------------|
| 1. Cooling system on temperature    | 80°F (27°C)           |
| 2. Heating system on temperature    | 50°F (10°C); optional |
| 3. High enclosure temperature alarm | 131°F (55°C)          |
| 4. Low enclosure temperature alarm  | -20°F (-28.8°C)       |
| 5. Audible and Visual alarm         | ON                    |
| 6. Digital display in degrees       | Fahrenheit            |
| 7. Filter maintenance alarm         | 0 days – Disabled     |
| 8. High condenser temperature alarm | 170°F (77°C)          |

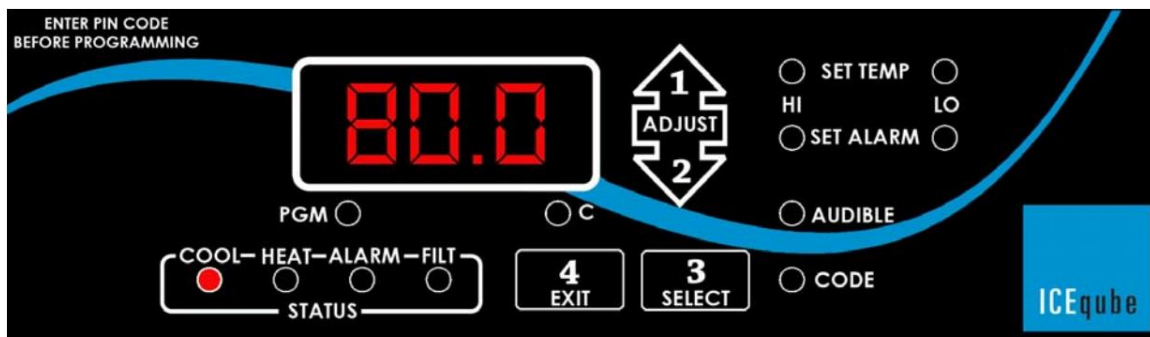

Figure 7: Standard Controller

To change the factory default settings, enter the programming code sequence below:

- “1 Adjust-up” arrow
- “2 Adjust-down” arrow
- “3 Select”
- “4 Exit”

After pressing the above sequence the program LED should illuminate along with three alternating flashing boxes on the display face, indicating the code was accepted. If no selection is made within 1 minute, the controller returns to the normal operating mode.

**Note: Pressing the “4 Exit” button at any time while in the programming mode returns the controller to the normal operating mode.**

The set temperature “HI” LED illuminates and the “COOL” LED will flash indicating the ‘cooling on’ setpoint. The compressor will begin operation at this temperature and will remain operating until the enclosure temperature decreases approximately 7°F (4°C). Press “1” or “2” until the desired set-point is displayed. The range for this adjustment is 70° to 126°F (21° to 52°C). When the adjustment is complete, press “3” to continue.

The set temperature “LO” LED is on and the “HEAT” LED will flash indicating the (optional) ‘heating on’ set point. The heating system will begin operation at this temperature and remain operating until the enclosure temperature increases approximately 7°F (4°C). Press “1” or “2” until the desired set point is displayed within a range of 0°F to 63°F (-17.8°C to +17°C). (Optional for controller Versions 3.22 and later)

Press “3” to continue. The set alarm “HI” LED is on with the display indicating the high temperature alarm set-point. The alarm will activate at this temperature and will automatically reset at 2°F (1°C) below this temperature. Press “1” or “2” to change the alarm set-point within a range of 8°F (4°C) above the set temperature “HI” set-point, to 131°F (55°C).

Press “3” to continue. The set alarm “LO” LED is on with the display indicating the low temperature alarm set point. The alarm will activate at this temperature and will automatically reset at 2°F (1°C) above this temperature. Press “1” or “2” to change the alarm set-point within a range of 8°F (4°C) above the set temperature “LO” set-point, to -20°F (-29°C). (Optional for controller Versions 3.22 and later)

Press “3” to continue. The “Alarm” LED will flash and the display will show “ALL” indicating the “ALL” alarm on/off status. Press “3” and the display will show either “ON” or “OFF”, indicating current alarm status. Press “1”

or “2” to toggle the mode as desired. If the “OFF” mode is selected, no alarms will activate and the audible on/off select and POA, Power Off Alarm, functions are skipped.

Press “3” to continue. The “Audible” LED will flash and the display will show “AUD”, indicating the audible alarm on/off status. Press “3” and the display shows “ON” or “OFF” indicating the current audible alarm status. Press “1” or “2” to toggle the mode desired.

Press “3” to continue. The “Alarm” LED will flash and the display will show “POA”, indicating the Power Off Alarm status. Press “3” and the display shows “ON” or “OFF” indicating the current alarm status. Press “1” or “2” to toggle the mode desired.  
(Version 3.18 and later only)

Press “3” to continue. The “C” LED will flash and the display will show either “F” for degrees Fahrenheit or “C” for degrees Celsius. Press “1” or “2” to toggle the mode desired.

Press “3” to continue. The “Code” LED will flash and the display will show “PIN”. To set a new user PIN code, press “1”. The display will flash “4”, prompting an entry of a four button sequence using the “1”, “2”, “3, and/or “4” buttons. Any sequence of the four buttons may be programmed as the code. As the buttons are pressed, the display will show the number of buttons that were pressed.

*Note: After pressing a button, there will only be 5 seconds to press the next button. If the next button is not pressed within the allotted time, the system will default to no PIN code, indicated by “0” on the display. Once the sequence is entered the display will no longer flash, and will show “4”.*

To program the no PIN code mode, press “2” and the display will show “0”, indicating no PIN code. With no PIN code, pressing any button will permit access to the program.

### •••CAUTION•••

#### ALWAYS RECORD THE SELECTION SEQUENCE (PIN CODE) AND STORE IN A SECURE PLACE

Press “3” to continue. The “filter” LED flashes and the display will show “FIL”, indicating the filter alarm day quantity selection. Press “3” and the display will show the number of days that the alarm is set in half day increments. Note that the alarm is based on compressor run time. (Example: 10.5 indicates that the alarm will activate every ten and a half days or 252 hours of compressor run time.)

Press “1” or “2” to vary the desired number of days. Programming “0” days will disable the alarm.

*Note: The required number of days to set this alarm will be determined by the ambient air conditions.*

Programming of the microprocessor is now complete. Press “3” to review all of the settings. Press “4” to enter the selected settings and to return to the normal operating mode.

*Note: if “4” is not pressed, any changes to the program settings will not be saved.*

## Alarm Operation

1. **The enclosure temperature is above or below the alarm set-point:**  
The “Alarm” LED will light, the display will flash, the “HI” or the “LO” LED will flash, and the audible alarm sounds (if activated.) The enclosure temperature must rise or fall 2°F (1°C) before the alarm will reset.
2. **The condenser temperature is above the condenser alarm set-point:**  
The “Alarm” LED lights, the display flashes the condenser temperature, and the audible alarm sounds (if activated.) the condenser temperature must fall 4°F (2°C) before the alarm will reset.  
**The above alarms can be manually reset by entering the PIN code into the system.**
3. **The filter day timer has expired:**  
The “Alarm” LED lights, the display flashes “FIL”, the “Filter” LED flashes with the display and the audible alarm sounds (if activated.) The filter alarm may be cleared by pressing “4 Exit”.
4. **The power is turned off:**  
The “Alarm” LED lights, and the display flashes “OFF” indicating someone has manually interrupted power to the motors’ electrical circuits. This alarm will be rest when the Por “ON” has been selected in the program menu. (Version 3.18 and later only)
5. **Optional Alarm Output:**  
Ice Qube offers an optional dry contact alarm output (XO3) that provides both a normally open (close on alarm) and a normally closed (open on alarm) set of contacts. This alarm signal is provided from a relay through a 3 conductor cable (*Black/Common, White/Normally Open, and Red/Normally Closed*) passing through a strain relief to the left of the internal controller.
6. **Sensor Malfunctions:**

E-O:	Evaporator sensor open
E-C:	Evaporator sensor shorted
C-O:	Condenser sensor open
C-C:	Condenser sensor shorted
Alternating E-O and C-O:	Sensor connector disconnected
7. **Incorrect Voltage Supply:**  
A continual flashing value of the program version (“3.1x” where x indicates current program version) on the display screen indicates the supply voltage is either too high or too low.

## Maintenance

The Ice Qube TMS is designed to provide many years of trouble-free operation with minimal amount of maintenance. Primary maintenance consists of checking the condition of the ambient air filter and the condensate management system.

### 1. Ambient Air Filter:

It is recommended that the ambient air filter be inspected and cleaned regularly: frequency will depend upon ambient conditions. To check the condition of the air filter, it is recommended to remove electrical power from the Ice Qube TMS. Next, locate the filter. Slide the filter from the internal filter rack through the end slot and clean by soaking in warm soapy water. Rinse with clean water. Use a shop-vac to remove excess water from the filter before returning it to the system. Replace the filter if it shows signs of deterioration. See website for air filter cleaning demonstration at <http://www.icecube.com/ice-qube-tv/>.

### 2. Condensate Management System:

The condensate management system should be checked periodically for scale, sludge and debris that may cause the system to fail. The type of environment will determine the frequency of required maintenance.

Maintenance of the condensate management system will require access to the bottom of the air conditioner. Removal of the neoprene tubing is necessary. Replacement of the tubing is recommended if it appears to have internal build-up or has become brittle. Using a soft tube/pipe cleaner, insert into the drain nipple and move in a circular motion to clear anything that may cause failure.

### 3. Cooling System Cabinet:

The cooling system cabinet and controller faceplate may also need to be cleaned occasionally.

#### PRECAUTIONS TO AVOID ELECTRICAL SHOCK HAZARD:

- A. Do not clean while electrical circuit is energized.
- B. Surfaces are to be cleaned only with a **damp cloth** to avoid build-up of electrostatic charge.

To clean the system cabinet and controller faceplate, simply wipe it with a damp, lint free cloth. A mild soap solution may be used if necessary.

## Trouble Shooting

Contact Ice Qube if the air conditioning system should fail to operate satisfactorily during the first year of operation. **DO NOT** remove the cover without first notifying customer service. **Removal of the cover will immediately void the warranty.**

If an operating problem should occur, please review the items outlined in the “Trouble Shooting Check List.” If the problem persists, obtain model and serial number before contacting Ice Qube for technical assistance.

## Trouble Shooting Checklist

<b>Model No:</b>		<b>Serial Number:</b>	
<b>Voltage Rating:</b>	<b>Amps:</b>	<b>Phase: 1</b>	<b>Frequency:</b>
<b>Options:</b>			
Is proper electrical power available at the power supply?		Yes <input type="checkbox"/>	No <input type="checkbox"/>
Is your power cord connected to the power supply and IQ terminal block?		Yes <input type="checkbox"/>	No <input type="checkbox"/>
Is the controller set-point temperature below the enclosure temperature?		Yes <input type="checkbox"/>	No <input type="checkbox"/>
Is the evaporator (cold air stream) blower operating?		Yes <input type="checkbox"/>	No <input type="checkbox"/>
Is the compressor and condenser (warm air stream) blower operating?		Yes <input type="checkbox"/>	No <input type="checkbox"/>
Is the enclosure door closed tightly?		Yes <input type="checkbox"/>	No <input type="checkbox"/>
Are all of the gaskets in place?		Yes <input type="checkbox"/>	No <input type="checkbox"/>
Has the condenser (warm air stream) filter been cleaned or changed recently?		Yes <input type="checkbox"/>	No <input type="checkbox"/>
Is the system mounted level on the enclosure?		Yes <input type="checkbox"/>	No <input type="checkbox"/>
Is there adequate space within the enclosure for air flow?		Yes <input type="checkbox"/>	No <input type="checkbox"/>
Is there adequate space around the air conditioner for airflow?		Yes <input type="checkbox"/>	No <input type="checkbox"/>
Has the enclosure population remained the same?		Yes <input type="checkbox"/>	No <input type="checkbox"/>
Notes:			

For additional support call:

Ice Qube at 1-888-867-8234

Please have above checklist completed before you call.



## Schematic Wiring Diagrams 120V/220V/230V/240V

FOR ZONE 2 ATEX/IECEX UNITS, ALL COMPONENTS ARE NON-IGNITION SOURCE COMPONENTS AND DO NOT REQUIRE PURGE PROTECTION FROM ANY SOURCE

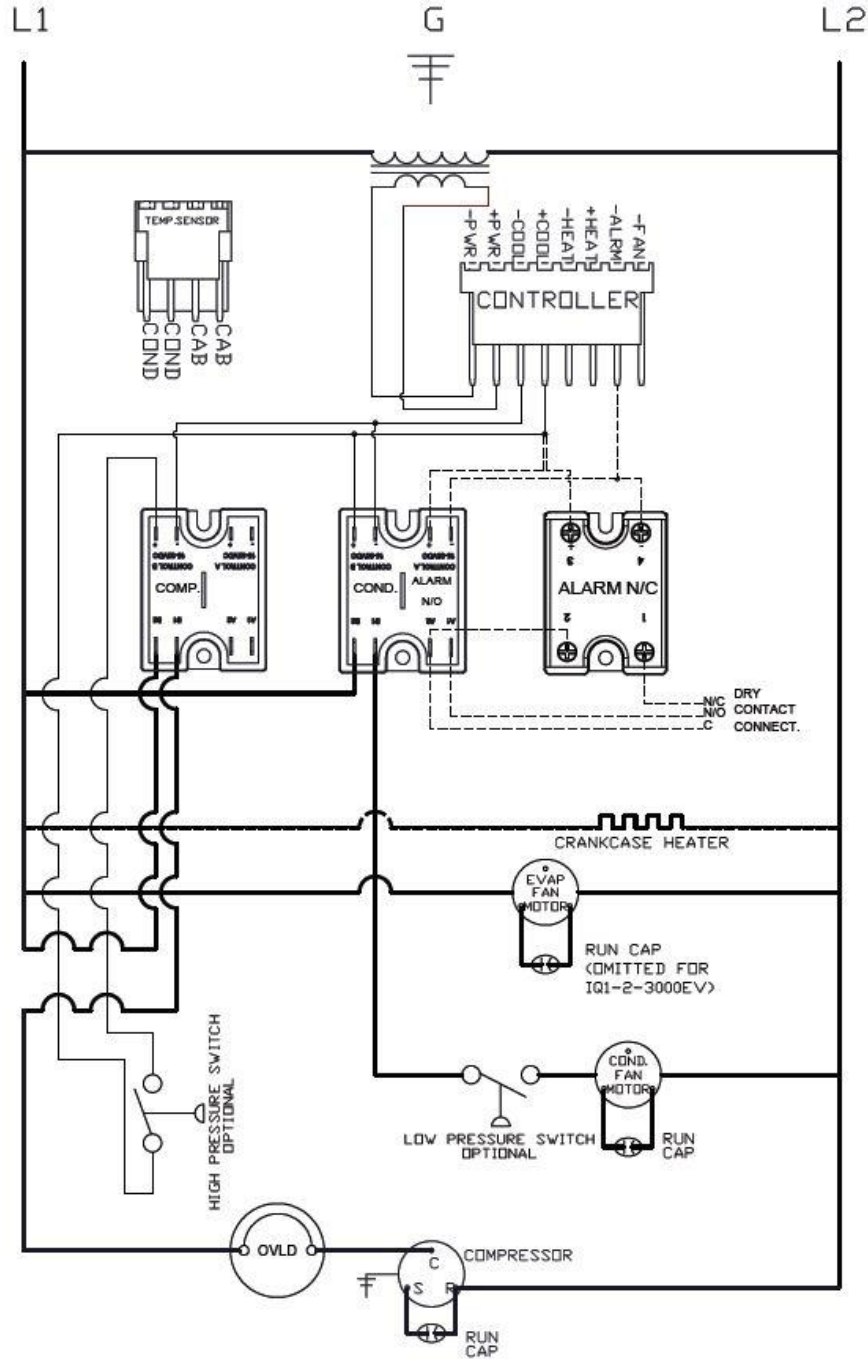

Figure 8

- Line Voltage
- - - Control Voltage (Low)
- · · Optional

IQ351153 Rev A

**400V/440V/460V/480V**

FOR ZONE 2 ATEX/IECEX UNITS, ALL COMPONENTS ARE NON-IGNITION SOURCE COMPONENTS AND DO NOT REQUIRE PURGE PROTECTION FROM ANY SOURCE

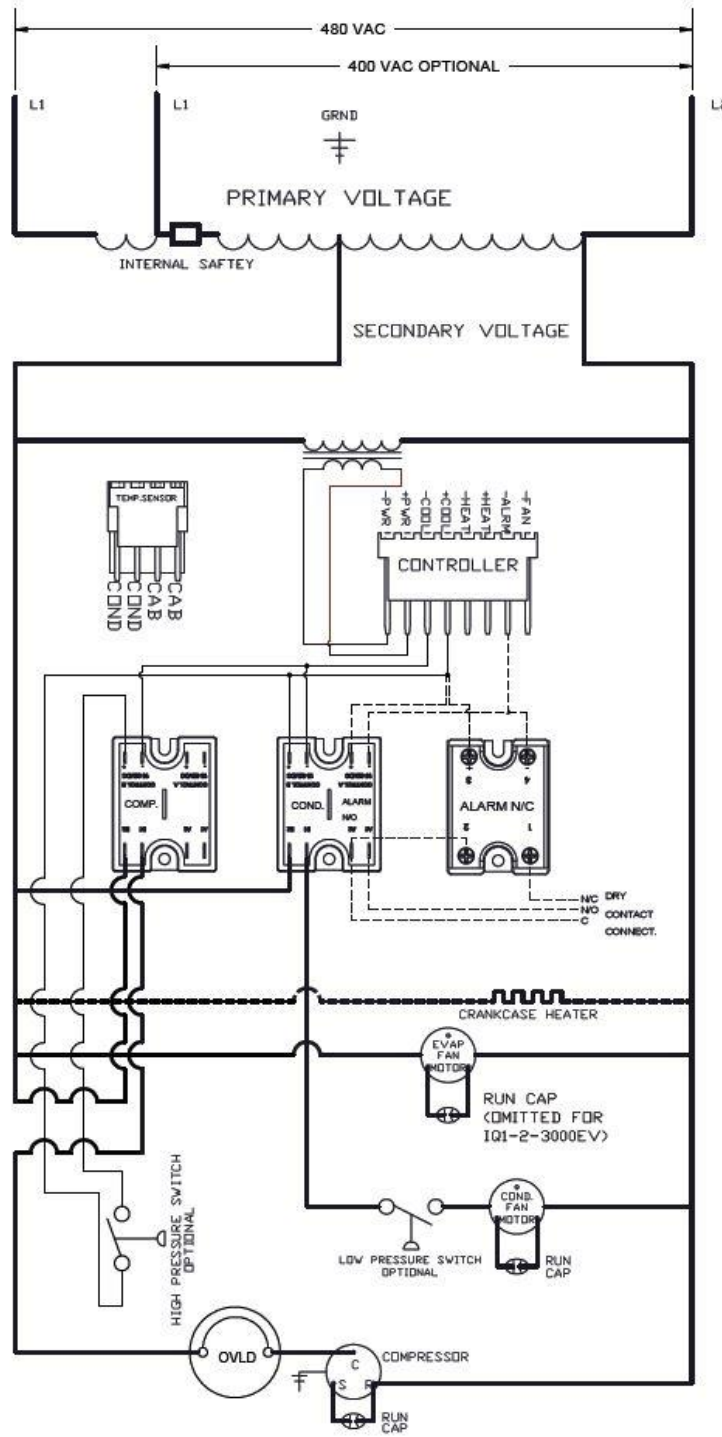

Figure 9

IQ351154 Rev A

- Line Voltage
- - - Control Voltage (Low)
- · · Optional



## Standard Warranty Policy

Ice Qube, Inc. ("Ice Qube") warrants that the products manufactured by Ice Qube (the "Products") are free of defects in material and workmanship which impair the operation of the Products, under normal and proper use and service, for a period of one (1) year from the date of shipment FCA from Ice Qube's facility located in Greensburg, Pennsylvania (the "Standard Warranty").

In order for this Standard Warranty to apply, the Product(s) must be installed and operated according to and consistent with the following conditions:

- Operation within the rated voltage on the label of the Product;
- Frequency variation no greater than +/- 3 HZ from rated frequency on the label of the Product;
- Ambient temperature must not exceed operating temperature range on the label of the Product;
- Maximum cooling capacity not to exceed rating (BTU/HR) as rated on the label of the Product; and
- The Product must be installed, maintained and operated consistent with the terms and conditions set forth in the operation manual.

### THIS STANDARD WARRANTY DOES NOT COVER THE FOLLOWING:

- Ice Qube assumes no liability beyond the repair or replacement of its own Products. In no event shall Ice Qube be liable for any incidental, special, indirect, consequential or similar damages incurred by any purchaser, owner, possessor, assignee or successor in interest or any other third party having any interest in any Product as the result of any breach of this Standard Warranty, including but not limited to loss of profit or revenues, damages for loss of use of the Products, damage to property, both real and personal, claims of third parties, including personal injury or death on account of use of the Products or failure of Ice Qube to warn against or instruct on or adequately warn against or instruct on, the dangers of the Products or the safe and proper use of the Products, whether or not customer has been advised of the potential for such damages.
- Ice Qube's total liability for customer's claims from any cause whatsoever, whether arising under contract, warranty, tort (including negligence), strict liability, products liability or any other theory of liability, will be limited to the lesser of customer's actual damages or the price paid by customer to Ice Qube for the Products (not including applicable taxes, duties and freight charges) that are the subject of customer's claim.

THE WARRANTY SET FORTH HEREIN IS STRICTLY LIMITED TO ITS TERMS AND IS IN LIEU OF ALL OTHER WARRANTIES, GUARANTEES, EXPRESS OR IMPLIED, ARISING BY OPERATION OF LAW, COURSE OF DEALING, CUSTOM, USAGE OF TRADE OR OTHERWISE, SPECIFICALLY EXCLUDING ANY IMPLIED WARRANTIES OF MERCHANTABILITY OR FITNESS FOR A PARTICULAR PURPOSE OR USE.

1. The warranty and remedies for breach of warranty provided for in this Standard Warranty extend only to the original installation and do not cover, and Ice Qube will neither assume responsibility, nor be liable, for the following:
  - misapplication of its Products or the erroneous selection of an inappropriate Product by a non-authorized Ice Qube representative;
  - use of the Product for other than its designed purpose or operating conditions;
  - operation or storage in harsh, oily, corrosive or other abnormal environments without the proper filtration, sealing, protective coatings and/or weather protection;
  - damage to the hermetic system resulting from continuous operation with dirty or clogged air filters or improper or negligent maintenance;
  - use of refrigerant other than designated on the label of the Product;
  - customer modification or abuse;
  - shipping damage or other accidental damage (It is Ice Qube's standard policy that freight claims are the responsibility of the customer if the Product is not refused at delivery);
  - repair, damage or service of the Product caused by anyone except personnel authorized by Ice Qube;
  - cracked or broken hermetic tubing, brazed joints or other internal damage caused by shipping or mishandling;
  - damage caused by shipping units attached to an enclosure;
  - any and all damage, breakage, malfunction or other like conditions or defects resulting from noncompliance with the standard operation, care, installation, maintenance and use of the Product as set forth in the operation manual for such Product;
  - any cause beyond the control of Ice Qube, including without limitation conditions caused by movement, settlement or structural defects of the environment in which the Products are installed;



- fire, wind, hail, flood, lightning or other acts of God;
  - any damage to the finish of the Products after they leave Ice Qube's facility;
  - any discoloration or spotty appearance of the Products;
  - return freight and shipping charges, along with applicable duties and other like fees and charges, for the return of the Product to Ice Qube (such amounts are the sole responsibility of the customer);
  - failure to process or inaccurate processing of time-sensitive information and/or mechanisms; or
  - Exposure to harmful chemicals, pollutants or other foreign matter or energy.
2. All returns must have a RMA number and must be marked with the RMA number on the bill of lading and on the packaging.
  3. Upon resale, customer agrees to extend to its customers no greater warranties, and limit its liability and remedies to the same extent, as those set forth herein.
  4. All Product literature is for illustrative purposes only and does not contain a warranty of any kind.
  5. Ice Qube's advice relating to the technical usage of the Products or the intellectual property rights of others, whether provided orally or in writing or through the provision of test results, is given in accordance with Ice Qube's best knowledge at that time, but shall at all times be deemed to be non-binding. Such advice does not relieve customer from the obligation, and customer accepts full responsibility, to confirm for itself the suitability of the Products for their intended purpose(s).

**Remedies**

Customer's sole and exclusive remedy, and Ice Qube's only obligation for breach of warranty hereunder shall be, at Ice Qube's option, in its sole discretion, to (i) repair or replace the defective Product which fails within the one (1) year warranty period, free of charge, provided that customer promptly notifies Ice Qube of such failure and, after receipt of prior written authorization and return authorization number from Ice Qube, which will be given or withheld at Ice Qube's sole discretion, returns such Product to Ice Qube, Inc., 141 Wilson Avenue, Greensburg, PA 15601, USA or such other place as requested by Ice Qube, freight prepaid, and thereupon Ice Qube finds such to be defective or (ii) issue a credit equal to the price of the defective Product which fails within the one (1) year warranty period. Customer must pay all related costs of repair or replacement, including removal, installation or reinstallation costs. Ice Qube's personnel must be granted access to inspect the Products claimed to be defective at the site of their installation or use. Products repaired or replaced and designs corrected under this Standard Warranty are warranted only for the remainder of the original warranty period.



Notes:

A large, empty grid of small squares, intended for handwritten notes or technical drawings.